

INSTRUCTION MANUAL

Serial Number 290

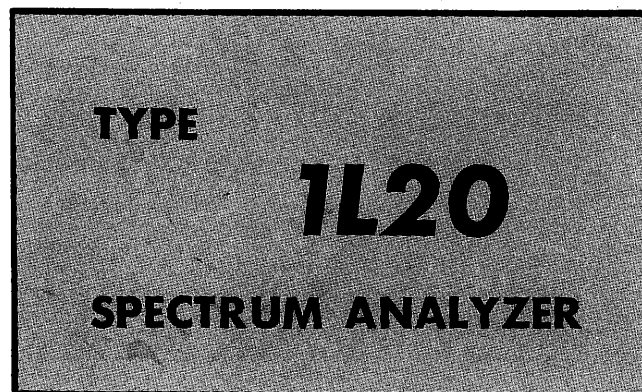

Tektronix, Inc.

S.W. Millikan Way ● P. O. Box 500 ● Beaverton, Oregon 97005 ● Phone 644-0161 ● Cables: Tektronix
070-0519-00



WARRANTY

All Tektronix instruments are warranted against defective materials and workmanship for one year. Tektronix transformers, manufactured in our own plant, are warranted for the life of the instrument.

Any questions with respect to the warranty mentioned above should be taken up with your Tektronix Field Engineer.

Tektronix repair and replacement-part service is geared directly to the field, therefore all requests for repairs and replacement parts should be directed to the Tektronix Field Office or representative in your area. This procedure will assure you the fastest possible service. Please include the instrument Type and Serial or Model Number with all requests for parts or service.

Specifications and price change privileges reserved.

Copyright © 1966 by Tektronix, Inc., Beaverton, Oregon. Printed in the United States of America. All rights reserved. Contents of this publication may not be reproduced in any form without permission of the copyright owner.



CONTENTS

Section 1	Characteristics
Section 2	Operating Instructions
Section 3	Circuit Description
Section 4	Maintenance
Section 5	Performance Check
Section 6	Calibration
	Parts Ordering Information
	Abbreviations and Symbols
Section 7	Electrical Parts List
	Mechanical Parts List Information
Section 8	Mechanical Parts List
Section 9	Diagrams
	Mechanical Parts List Illustrations
	Accessories

Abbreviations and symbols used in this manual are based on or taken directly from IEEE Standard 260 "Standard Symbols for Units", MIL-STD-12B and other standards of the electronics industry. Change information, if any, is located at the rear of this manual.

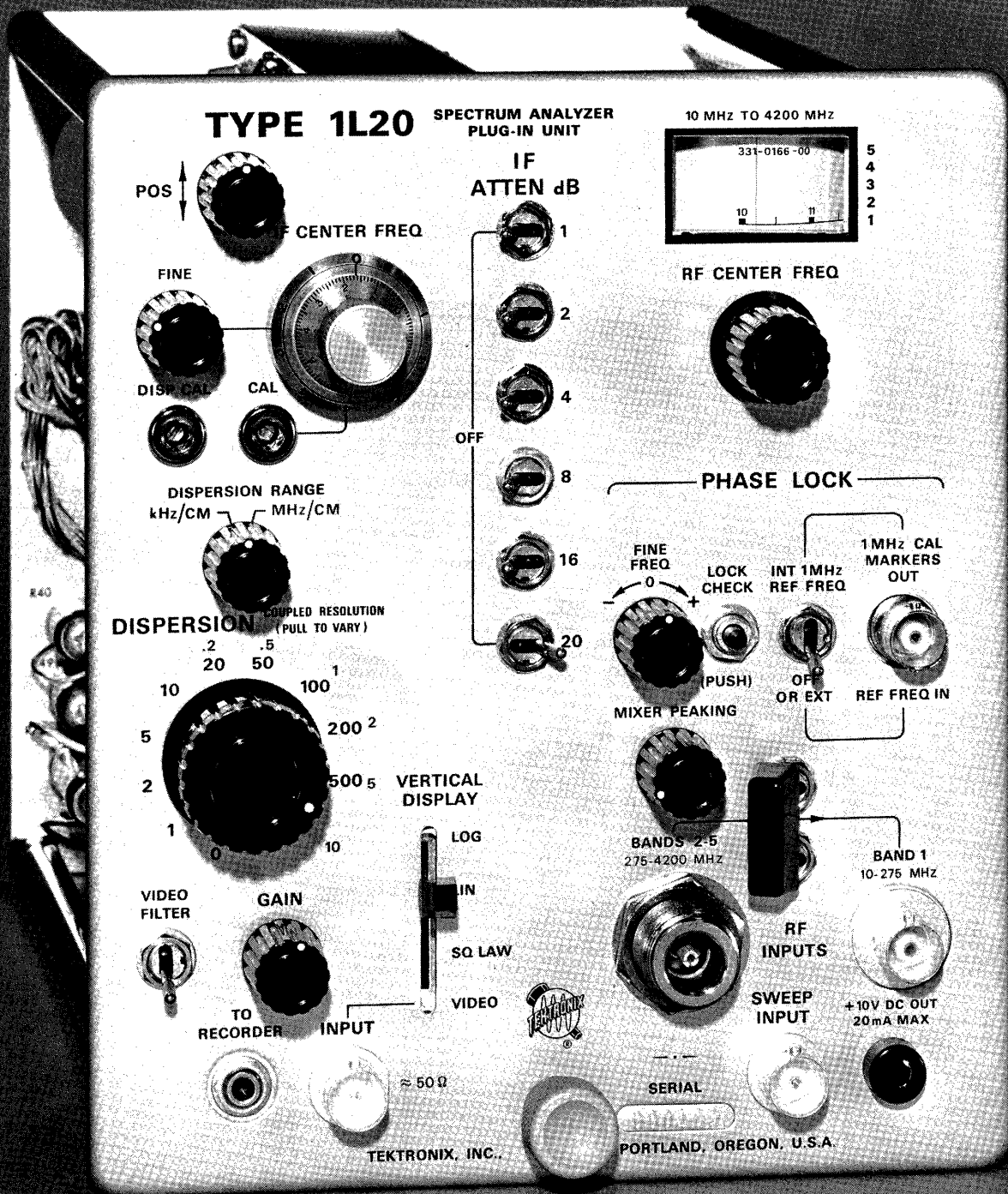

Fig. 1-1. Type 1L20 Spectrum Analyzer.

SECTION 1

CHARACTERISTICS

The Type 1L20 Spectrum Analyzer described in this manual is designed for use in Tektronix oscilloscopes for the panoramic presentation of RF signals in the frequency range of 10 MHz to 4200 MHz. The analyzer displays the frequency distribution of the applied signal along the horizontal axis of the oscilloscope CRT and displays the signal energy on the vertical axis.

The analyzer is designed for use in all Tektronix 530-, 540-, 550-, and 580-Series Oscilloscope. The analyzer plugs directly into the oscilloscope and derives all its power

from the oscilloscope. The Type 1L20 can also be used in an external Plug-In Unit Power Supply such as the Tektronix Type 127 and Type 132 Power Supplies when provided with a 100 volt sawtooth signal.

The following electrical characteristics apply at an ambient temperature of 25° C ($\pm 5^\circ$ C) after an initial warmup period of 20 minutes.

¹A Tektronix Type 81 Plug-In Adapter must be used with 580-Series Oscilloscopes.

CHARACTERISTICS

Characteristic	Performance Requirement	Supplemental Information
Input Frequency		
Range	10 MHz to 4200 MHz—See Table 1-1	
Sensitivity	—See Table 1-1	
Dial Accuracy	$\pm (2 \text{ MHz} + 1\% \text{ of dial reading})$	
Dispersion		
kHz/CM RANGE		
Range	1 kHz/cm to 500 kHz/cm and 0 dispersion	In 1-2-5 sequence
Accuracy	$\pm 3\%$	
Linearity	$\pm 3\%$	
MHz/CM RANGE		
Range	.2 MHz/cm to 10 MHz/cm	In 1-2-5 sequence; useful dispersion limited to .2-5 MHz/cm in Band 1
Accuracy	See Table 1-2	
Linearity	$\pm 3\%$	
Sweep Latch-up	Sweep latch-up can not occur at any kHz/CM DISPERSION setting when the IF CENTER FREQ control is within ± 1 major division of 000 (midrange).	

TABLE 1-1

Band	RF CENTER FREQ in MHz	Sensitivity ²		Remarks
		1 kHz RESOLUTION	100 kHz RESOLUTION	
1	10-275	-100 dBm (2.2 μ V)	-80 dBm (22.5 μ V)	For Bands 2-5, FINE FREQ control must be turned fully clockwise, MIXER PEAKING set for optimum signal.
2	275-900	-110 dBm (0.7 μ V)	-90 dBm (7.0 μ V)	
3	850-2000	-100 dBm (2.2 μ V)	-80 dBm (22.5 μ V)	
4	1950-3100	-95 dBm (4.0 μ V)	-75 dBm (40 μ V)	
5	3000-4200	-90 dBm (7.0 μ V)	-70 dBm (70.0 μ V)	

²50 Ω load impedance; all voltages are RMS.

TABLE 1-2

DISPERSION/CM		Remarks
Setting	Accuracy	
10 MHz	$\pm 3\%$ (± 0.3 MHz/cm)	Over the 50 MHz range of the IF CENTER FREQ control. The DISPERSION CAL adjust can be reset to improve the accuracy at a specific IF CENTER FREQ control setting by using the front panel 1 MHz CAL MARKERS OUT as a calibration signal.
5 MHz	$\pm 3\%$ (± 0.15 MHz/cm)	
2 MHz	$\pm 5\%$ (± 0.1 MHz/cm)	
1 MHz	$\pm 7\%$ (± 70 kHz/cm)	
.5 MHz	$\pm 10\%$ (± 50 kHz/cm)	
.2 MHz	$\pm 15\%$ (± 30 kHz/cm)	

Characteristics—Type 1L20

Characteristic	Performance Requirement		Supplemental Information
Resolution Range	1 kHz to 100 kHz; uncalibrated		Can be cross-coupled with DISPERSION control or switched separately
IF CENTER FREQ Range	Coarse Control	FINE control	
1-500 kHz/CM Dispersion	$\geq (\pm 2.5 \text{ MHz})$	$\geq (\pm 50 \text{ kHz})$	
.2-5 MHz/CM Dispersion	$\geq (\pm 25 \text{ MHz})$	$\geq (\pm 1 \text{ kHz})$	
10 MHz/CM Dispersion	$\geq (\pm 10 \text{ MHz})$	$\geq (\pm 1 \text{ kHz})$	
IF GAIN Control Range	$\geq 50 \text{ dB}$		
IF ATTEN Control Range	0—51 dB		In 1 dB steps
Accuracy	$\pm .1 \text{ dB/dB}$		
Display Flatness IF & Local Oscillator	$\pm 1.5 \text{ dB}$ (Except for 10 MHz/CM DISPERSION on Band 1)		$\pm 50 \text{ MHz}$ from center frequency
Incidental FM IF	$< 200 \text{ Hz}$		
IF + Local Oscillator	$\leq 300 \text{ Hz}$		At L. O. fundamental with phase lock
Phase Lock Internal Markers	1 MHz \pm 100 Hz		Crystal-controlled
External Marker Requirements	1 MHz to 5 MHz; 1 V to 5 V, p-p		
Dynamic Range LOG	$\geq 40 \text{ dB}$		
LIN	$\geq 26 \text{ dB}$		≥ 6 centimeter display
SQ LAW	$\geq 13 \text{ dB}$		
VIDEO INPUT Response	$\leq 16 \text{ Hz}$ to $\geq 10 \text{ MHz}$		
TO RECORDER Sensitivity	12 mV to 20 mV		With G centimeter LIN Display
+ 10 V OUT (Front Panel)	10 V $\pm 5\%$		20 mA maximum load current

Environmental Conditions

The instrument will operate over a room-temperature of 0° C to +50° C after 20 minutes warm-up time. Ventilation adequate for the main oscilloscope is adequate for this plug-in unit.

Finish

Front panel is anodized aluminum.

Connectors

1 MHz CAL MARKERS OUT	BNC
SWEEP INPUT	BNC
VIDEO INPUT	BNC
BAND 1 RF INPUT	BNC
BANDS 2-5 RF INPUT	'N'
+10 V DC OUT	Banana Jack
TO RECORDER	Miniature Phone Jack

SECTION 2

OPERATING INSTRUCTIONS

General

To effectively use the Type 1L20 Spectrum Analyzer, the operation and capabilities of the instrument must be known. This section describes the operation of the front-panel controls and connectors, gives first-time and general operating information, and lists some basic applications for the instrument.

Controls and Connectors

A front panel view of the Type 1L20 Spectrum Analyzer is shown in Fig. 2-1. A brief functional description of the controls, connectors and securing latch is included.

FIRST-TIME OPERATION

The following procedure demonstrates the function of the various front-panel controls and is intended to help you become familiar with its operation.

1. Set the slide switch SW201 (mounted on the rear plate of the Type 1L20) to the appropriate sawtooth voltage as listed in Table 2-1. (If your oscilloscope is not listed, check the specifications given in its Instruction Manual for the front-panel SAWTOOTH OUT waveform.)

TABLE 2-1

100 Volt Sawtooth	150 Volt Sawtooth
Type 544	All 530-Series
Type 546	Type 543 (A & B)
Type 547	Type 545 (A & B)
Type 556	Type 549
	Type 555
	All 580-Series
	Type T Plug-in Unit

2. Insert the Spectrum Analyzer into the plug-in compartment and fasten the securing latch. Turn on the power.

3. Connect the oscilloscope Sawtooth Out (or Sawtooth A) connector to the Analyzer SWEEP INPUT connector.

WARNING

Shock hazard exists at the oscilloscope Sawtooth Out connector.

4. Set the oscilloscope for a free-running 1 ms/cm sweep. (In actual practice, the oscilloscope may be set to any desired sweep rate between 5 s/cm and 1 ms/cm.) Set the oscilloscope Mode (or Horizontal Display) switch to "A" or Normal.

5. Preset the following front-panel controls:

POS	Midrange
IF CENTER FREQ	Midrange (000)
DISPERSION RANGE	MHz/CM

DISPERSION-COUPLED RESOLUTION	10 (outer ring)
VIDEO FILTER	Off (down)
GAIN	Midrange
VERTICAL DISPLAY	LIN
INT 1 MHz REF FREQ	On (up)

6. Connect a signal in the frequency range between 10 and 4200 MHz to the appropriate RF INPUT connector and switch the RF INPUT switch to the appropriate position (BAND 1—10-275 MHz; BANDS 2-5—275-4200 MHz). If the signal strength is greater than -30 dBm (7 mV RMS) on external attenuator should be used. If a steady, drift-free signal is not available, connect a cable between the BAND 1 RF INPUT connector and the 1 MHz CAL MARKERS OUT connector.

7. At this point, there should be a trace displayed on the CRT. If there is not, adjust the POSITION and INTENSITY controls. Once the trace is on the CRT, set the FOCUS, ASTIGMATISM, and INTENSITY controls for a well-defined display. The POSITION controls should be set so that the trace starts just outside the lower-left corner of the graticule.

8. Set the RF CENTER FREQ control to the frequency of the incoming signal. (Set the control to 10-20 MHz if using the 1 MHz CAL MARKERS signal.) A spectrum display of the signal should appear on the CRT.

9. Turn the GAIN control and/or the IF ATTEN switches so that the vertical deflection is at a convenient amplitude.

10. Move the spectrum display across the screen using the RF CENTER FREQ control. Note that some of the signals move at different rates. (See Harmonic and Image Frequency Displays, Page 2-4.)

11. Center the signal on the CRT, using the RF CENTER FREQ control.

12. Move the spectrum display across the CRT, using the IF CENTER FREQ controls. Note that all the spikes now move the same amount and in the same direction. Center the IF CENTER FREQ controls.

13. Change the oscilloscope sweep rate to 50 ms/cm and note the increased amplitude and detail in the display. Set the sweep rate to 10 ms/cm.

14. Hold in the LOCK CHECK button and change the RF CENTER FREQ control. Note that as the Local Oscillator is tuned the trace shows oscillation building up to an amplitude of about 2 centimeters, suddenly changes to a single line as it locks in and then changes back to the oscillation display when the oscillator passes out of the phase-lock range.

15. Set the RF CENTER FREQ and FINE FREQ controls to the middle of the phase-locked range, release the LOCK CHECK button, and center the signal with the IF CENTER FREQ control.

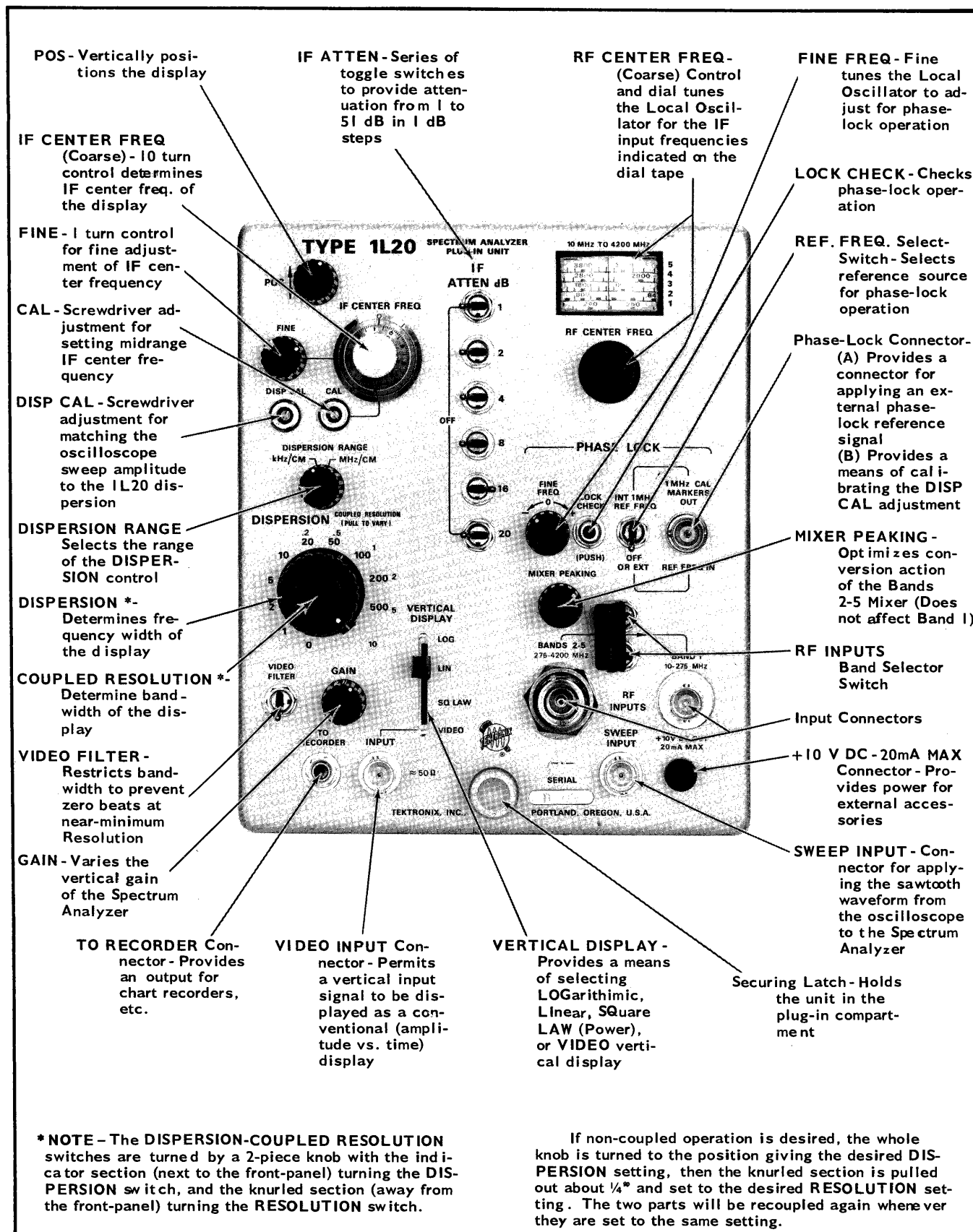

Fig. 2-1. Function of Type 1L20 front-panel controls and connectors.

16. Change the DISPERSION RANGE switch to kHz/CM and set the DISPERSION-COUPLED RESOLUTION switch to 10 (inner ring).

17. Note the setting of the FINE FREQ control. Slowly rotate the control through this setting. Note that the signal will stay locked in place while the control is rotated through 10 to 15 degrees.

18. Disable the phase-lock action by changing the FINE FREQ control. Note the increased horizontal drift and FM shift. (If necessary, bring the signal back onto the CRT by adjusting the IF CENTER FREQ controls.)

19. Pull out on the COUPLED RESOLUTION knob and rotate it toward the clockwise end of its rotation without changing the DISPERSION setting. Note the broadening of the displayed signal.

FRONT PANEL ADJUSTMENTS

Any time the Type 1L20 Spectrum Analyzer is moved from one oscilloscope to another, the front-panel IF CENTER FREQ CAL and DISP CAL adjustments must be recalibrated to compensate for differences in sawtooth amplitude and CRT sensitivity. These adjustments should also be checked occasionally during the regular use of the instrument.

1. IF CENTER FREQ CAL Adjustment

a. Set the front panel controls and connect the Spectrum Analyzer to the oscilloscope as directed in steps 1 through 6 of First Time Operation.

b. Apply an external signal (10-4200 MHz) to the appropriate RF INPUT connector.

c. Tune in the signal with the RF CENTER FREQ control and adjust the GAIN and IF ATTEN controls for a signal amplitude of about 5 centimeters.

d. Set the RF CENTER FREQ control for no signal shift as the DISPERSION RANGE control is switched back and forth between the MHz/CM and kHz/CM positions.

e. Set the IF CENTER FREQ CAL adjustment for no signal shift as the DISPERSION-COUPLED RESOLUTION control is rotated.

f. Position the signal to the graticule center with the oscilloscope HORIZONTAL POSITION control. (On some oscilloscopes, it may be necessary to readjust R204, the internal Swp Ctr adjust, located 3 inches behind the analyzer GAIN control.)

2. DISP CAL Adjustment

a. Set the Type 1L20 front-panel controls as follows:

IF ATTEN	All OFF
IF CENTER FREQ	000 (centered)
DISPERSION RANGE	kHz/CM
DISPERSION-COUPLED RESOLUTION	500
VERTICAL DISPLAY	SQ LAW

RF INPUTS (switch)

BANDS 2-5

PHASE LOCK

INT 1 MHz REF FREQ

b. Connect the 1 MHz CAL MARKERS OUT signal to the BANDS 2-5 RF INPUT connector.

c. Adjust the GAIN control for a marker display about 3 centimeters in height.

d. Use the FINE IF CENTER FREQ control to keep the markers aligned with the graticule lines while setting the DISP CAL adjustment for 1 marker/2 centimeters.

Applied Signal Precautions

Signals applied to the RF INPUT connectors should be connected through a 50-ohm coaxial cable, using a BNC connector for Band 1 (10 MHz to 275 MHz) signals and a Type N connector for Bands 2-5 (275 MHz to 4200 MHz). Unshielded connections will tend to pick up stray unwanted signals and cause a confusing display.

Reflections caused by mismatches between the signal source and the Type 1L20 RF INPUT sometimes cause "dips" in the signal display on the CRT. When good conversion flatness is desired and sufficient signal strength is available, a 6 dB 50 Ω attenuator pad can be inserted between the source and the Analyzer to minimize these reflections.

The signal applied to the RF INPUT should not be stronger than -30 dBm (7 millivolts RMS) for an undistorted display. (See Fig. 2-2). As a matter of practice, stay well away from the point where compression (no increase in height with an increase in signal strength) is noticed. Back off at least 10 dB from this point. Otherwise, the Spectrum Analyzer might be over-driven, resulting in the generation of spurious responses due to harmonic mixing at a much higher level than normal.

At times, this harmonic mixing may be advantageous—such as during parts of the Calibration Procedure when it is desired to calibrate the instrument using harmonics of the Time-Mark Generator. Normally, however, such operation will only lead to a confusing display.

At no time should signals stronger than $+15$ dBm (1 volt RMS) be applied to the Spectrum Analyzer. Signals above this limit are apt to damage the diode mixers in the RF INPUT circuits.

Vertical Display

An RF signal is displayed on the screen of the Spectrum Analyzer as a pip, with the amplitude of the pip representing the signal strength and the horizontal displacement representing the frequency of the signal. The shape of the pip is a function of the IF response of the Analyzer. In the Type 1L20, the response can be adjusted by the front panel RESOLUTION control in ten steps from 1 kHz (fully counterclockwise) to 100 kHz (fully clockwise).

Pulsed signals can be displayed on the screen as a series of lines, the locus of which represent the energy distribution of the signal as a function of frequency. Frequency domain representations for a wide variety of waveforms are to be found in Design Data for Radio Engineers, ITT Handbook, Chapter 35.

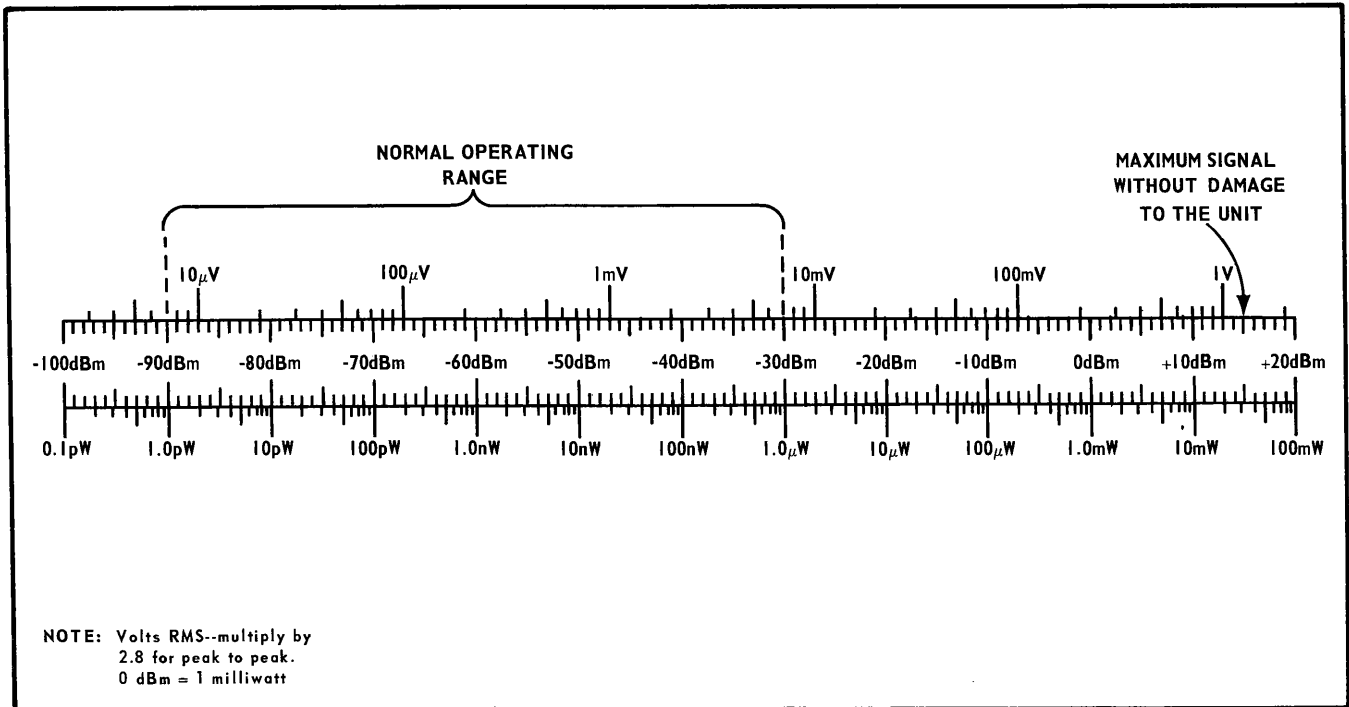

Fig. 2-2. Volts—dBm—Watts Conversion Chart for 50 Ω Impedance.

The appearance of the signal display depends to a great extent on the setting of the VERTICAL DISPLAY switch. For instance, the side lobes will be accentuated when operating in LOG (40 dB full screen) as compared to SQ LAW (13 dB full screen). Fig. 2-3 shows a single signal being displayed in all four VERTICAL DISPLAY MODES.

Linear

The Linear mode will be used for most applications, and where the relative differences between the signal amplitude are not too great.

Logarithmic

The Logarithmic mode increases the dynamic range of the display by attenuating large signals more than small signals, following an approximate logarithmic curve. This is basically a compression circuit and will be used when there are large differences between signal amplitudes.

Square Law

The output of this circuit is approximately proportional to the square of the input voltage; therefore the vertical deflection of the beam will be approximately proportional to the power of the signal. This is basically an expansion circuit and will be used when the differences between the signal amplitudes are very slight.

VIDEO

In this mode, the spectrum display is grounded and a signal connected to the front-panel VIDEO INPUT con-

ductor will be displayed as a conventional analog (time versus signal amplitude) display. An uncalibrated GAIN control provides variable sensitivity. Maximum sensitivity is approximately 0.1 volt per centimeter.

The impedance of the VIDEO INPUT circuit is approximately 50 ohms; therefore high-impedance probes cannot be used to couple signals to the VIDEO circuit.

Harmonic and Image Frequency Displays

Before making any measurements of a displayed signal (or signals), it must be determined that the signal is not a harmonic or an image frequency. To determine if the displayed signal is the signal indicated by the RF CENTER FREQ dial, proceed as follows:

1. With the signal in question displayed on the CRT, set the DISPERSION-COUPLED RESOLUTION and DISPERSION RANGE switches to 10 MHz/CM.
2. Turn the RF CENTER FREQ control in the direction of increasing frequency. The signal must move from left to right. If not, the observed signal is an image frequency and the RF CENTER FREQ dial must be set 400 MHz (twice the IF of the Type 1L20) above its present reading to observe the true signal.
3. Move the RF CENTER FREQ control so that the displayed signal is on the center graticule line and note the reading of the dial on the band you believe to be the correct band.
4. Move the signal to the right end of the graticule and note the reading again. If the dial reading changed 50 MHz, you are reading the correct band. If it changed less than 50 MHz, try a higher frequency band; if it changed more than 50 MHz, try a lower frequency band.

5. If the signal did not move when the RF CENTER FREQ control was changed, you are watching an IF feedthrough signal.

MIXER PEAKING Control Operation

The front-panel MIXER PEAKING control has been provided to improve the over-all sensitivity of the Spectrum Analyzer on Bands 2-5. (It will have no effect on Band 1 signals.) Its action is quite broad; therefore it can usually be set at an optimum setting and will not need to be changed unless there is a large change in signal frequency.

As a very rough guide, the MIXER PEAKING control will be set near the counterclockwise end of its rotation for Band 2; near the middle of its range for Bands 3 and 4; and near either end for Band 5.

Phase Lock Operation

The Phase Lock circuit increases the horizontal (frequency) stability of narrow-dispersion displays by locking the Local Oscillator in phase with a more stable reference signal. This reference signal can come from one of two sources—either the internal crystal-controlled 1 MHz reference oscillator, or an external 1.5 MHz reference signal applied to the front-panel REF FREQ IN connector.

The Spectrum Analyzer is set up for phase-locked operation as follows:

1. Set both IF CENTER FREQ controls to midrange.
2. Center the signal on the graticule with the RF CENTER FREQ control.

3. Connect the external reference signal, if used, to the REF FREQ IN connector and set the REF FREQ switch to the desired reference source.

4. Hold in the LOCK CHECK pushbutton and set the RF CENTER FREQ and FINE FREQ controls to the closest phase-locked range. (Figure 2-4 shows the display that results from depressing the LOCK CHECK pushbutton while turning the RF CENTER FREQ control through a phase-locked range. In actual practice, the RF CENTER FREQ control is usually set to center the desired RF INPUT signal and phase lock is accomplished by readjusting the FINE FREQ control.)

Under some conditions, small beat signals will appear between two successive large beats (see Fig. 2-5). These lock points may be used, but the oscillator may tend to drop out of lock easier than when locked with the larger beat signals.

5. Release the LOCK CHECK pushbutton and set the DISPERSION—COUPLED RESOLUTION switches to the desired settings. If it is necessary to re-center the signal, use the IF CENTER FREQ controls; do not move the RF CENTER FREQ or FINE FREQ controls after the Analyzer is set for phase lock.

When using DISPERSION settings of 100 kHz/CM or narrower, the desired RF INPUT signal may disappear off the screen when phase lock is lost; a slight adjustment of the FINE FREQ control will bring the Analyzer back into a phase-lock mode and return the signal under observation to the screen.

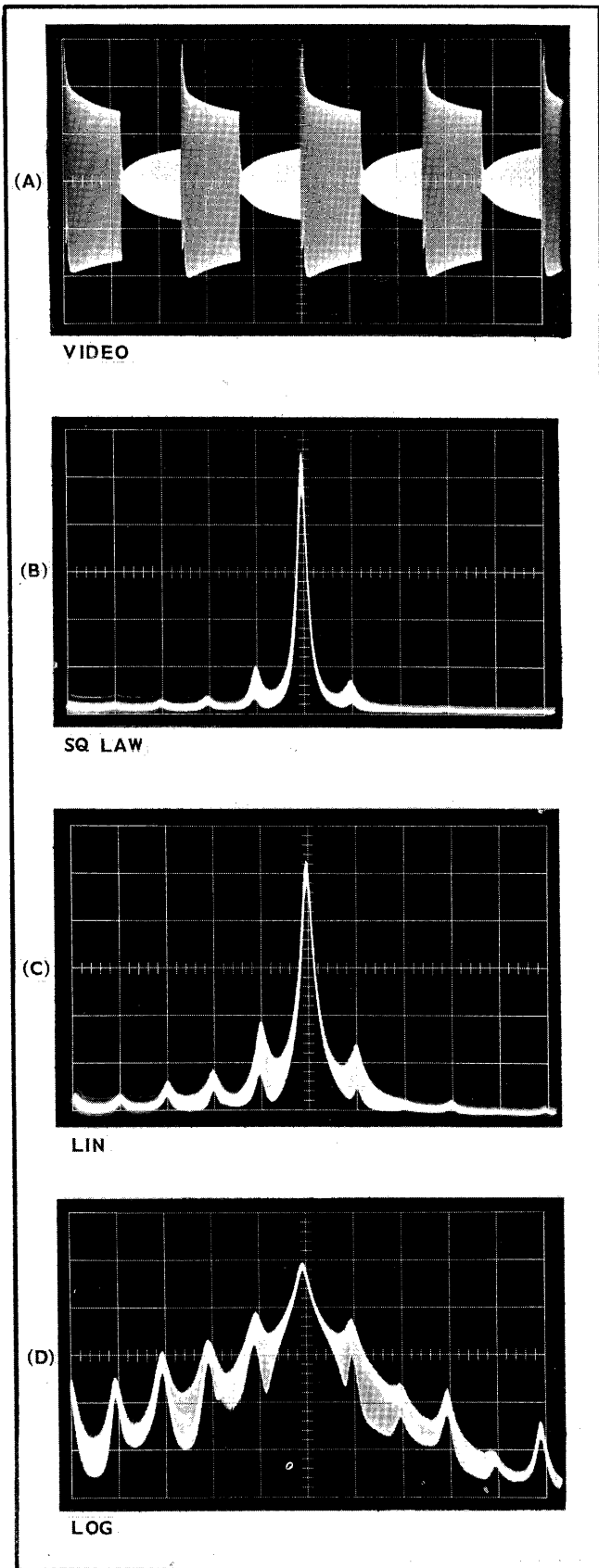

Fig. 2-3. VERTICAL DISPLAY Modes showing a 10 MHz carrier signal modulated by 10 kHz.

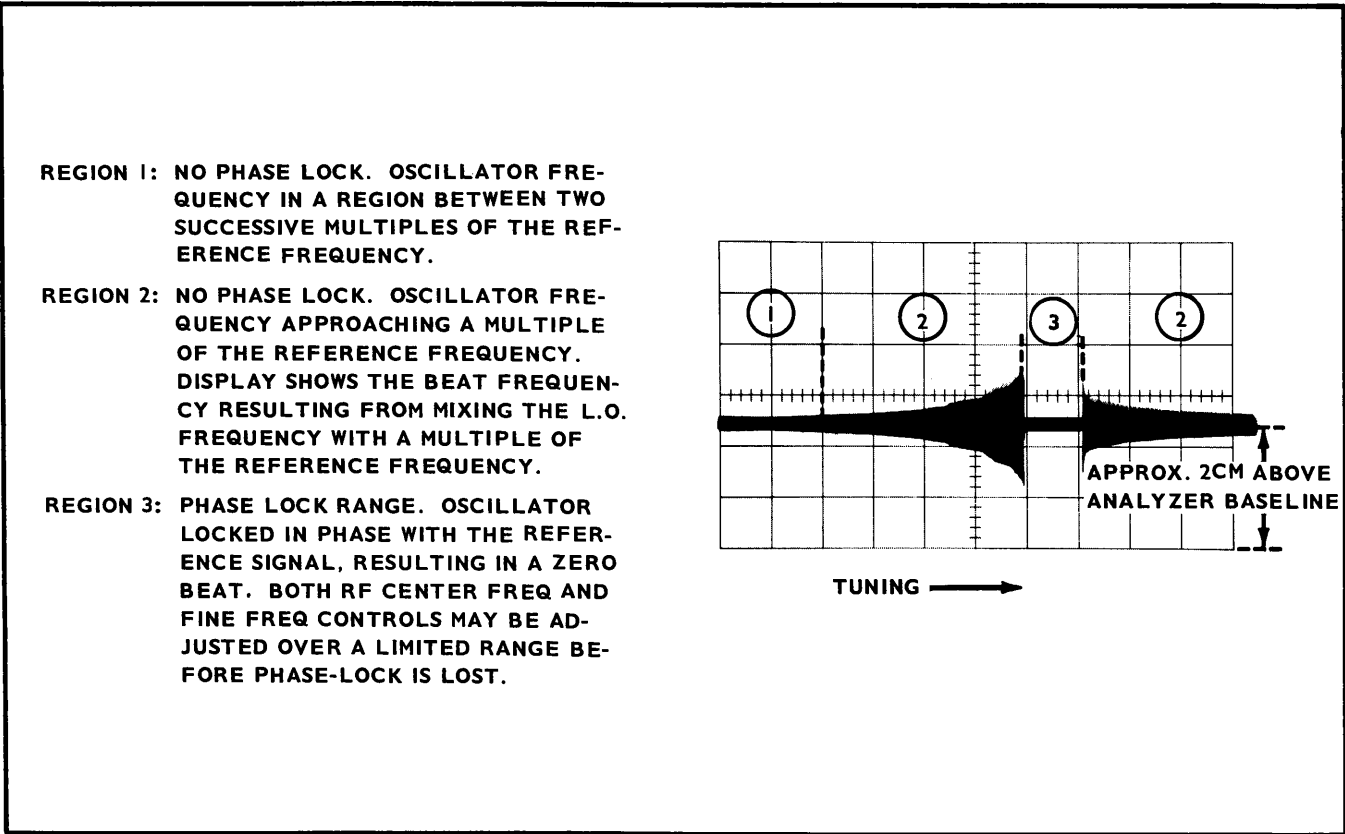

Fig. 2-4. LOCK-CHECK display.

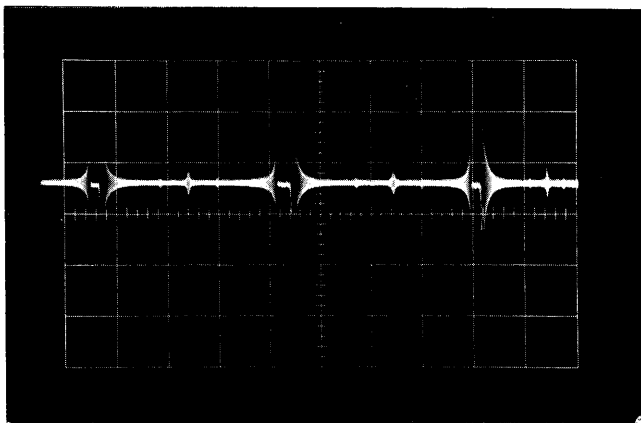

Fig. 2-5. Phase-Lock display showing large and small beat signals.

VIDEO FILTER Operation

The video filter is switched in to restrict the video bandwidth so as to prevent zero beats when observing signals separated by the minimum resolution of the unit. The filter also has the effect of suppressing the noise level and thereby improving the sensitivity in the narrow resolution positions. This filter action is obtained at the cost of usable sweep speed—to avoid a distorted display, the sweep rate must be reduced to about 50 ms/cm or slower.

The video filter will be useful in the following cases:

- a. When attempting to observe two or more signals separated in frequency by the minimum resolution (1 kHz) of the unit.
- b. When it is desired to observe only the envelope of a pulsed signal as opposed to observing the repetition rate lines.
- c. When it is desired to obtain a clean, crisp display eliminating all high frequency phenomena such as baseline noise and beats between signals, and transient response when observing pulsed signals.

Sweep Latch Up

On some Type 1L20 Spectrum Analyzers, the frequency sweep might latch up occasionally, as indicated by a sudden loss of dispersion when switching the DISPERSION RANGE control from MHz/CM to kHz/CM. This condition is caused by the kHz/CM Frequency Discriminator locking in on the wrong side of its response curve; to restore it to normal operation either turn the IF CENTER FREQ control to a setting closer to 0 or momentarily set the DISPERSION switch to a clockwise position.

Obtaining Maximum Dispersion Accuracy

The dispersion accuracy of the MHz/CM ranges may vary considerably as the setting of the IF CENTER FREQ

control is changed. This will be especially evident when using the .2MHz/CM and .5MHz/CM setting. Since the same dispersion/cm displays are available at 200 kHz/CM and 500 kHz/CM, but with a considerable increase in accuracy, it is recommended that the kHz/CM settings be used when precise measurements are needed and when the decreased IF CENTER FREQ control range (+ and - 2.5 MHz versus + and - 25 MHz) is acceptable.

The front-panel DISP CAL adjustment (in conjunction with the 1 MHz CAL MARKERS OUT signal) can be reset to improve the dispersion accuracy for specific setting of the IF CENTER FREQ control. This is accomplished as follows:

1. Set the front-panel controls for the desired signal display.
2. Connect the 1 MHz CAL MARKERS OUT signal to the RF INPUT connector and set the DISP CAL adjustment to give the correct marker/division display.
3. Reconnect the external signal to the RF INPUT connector and make the desired measurements.
4. Be sure to recalibrate the DISP CAL adjustment when finished with step 3; center the IF CENTER FREQ controls, set the DISPERSION/CM to 500 kHz, connect the 1 MHz MARKERS to the RF INPUT connector, and reset the DISP CAL adjustment for 1 marker/2 divisions.

Obtaining Optimum Resolution

The resolution of a Spectrum Analyzer is the measure of the instrument's ability to separate individual signals. The resolution is a function of the IF bandwidth, sweep frequency rate, and dispersion. At very slow sweep rates, the effective resolution of the analyzer is determined by the -6 dB bandwidth of its IF circuits and will closely resemble the IF response curve.

The effective resolution at a specific sweep rate and dispersion is given by:

$$R = B \left[1 + 0.195 \left(\frac{D}{TB^2} \right)^2 \right]^{1/2}$$

where:

- R = Resolution
- B = Bandwidth in hertz
- D = Dispersion in hertz
- T = Sweep time in seconds

The sensitivity of the instrument is also dependent on the same factors. The sensitivity to be expected can be calculated mathematically as:

$$S = S_0 \left[1 + 0.195 \left(\frac{D}{TB^2} \right)^2 \right]^{1/4}$$

where:

- S = Sensitivity
- S₀ = Sensitivity at very slow sweep speeds and zero dispersion
- D = Dispersion in hertz
- T = Sweep time in seconds
- B = Bandwidth in hertz

Usually, the resolution of the Spectrum Analyzer will be near optimum at a given setting of the DISPERSION controls when the DISPERSION and COUPLED RESOLUTION controls are coupled together (both switches set to the same position), although the RESOLUTION control can be turned separately if desired by pulling out on the knurled section of the knob.

The time base of the oscilloscope should be set for the fastest sweep rate at which no distortion or amplitude loss is noticed in the display. If the Spectrum Analyzer is being used in combination with a Type 549 Storage Oscilloscope, the slow-sweep display may be easier to analyze if the oscilloscope is operated in the Storage Mode.

Sensitivity of the Spectrum Analyzer to pulse signals is a function of the bandwidth of the instrument as stated above. However, if the bandwidth is too large, the minima of the spectrum are no longer zero. To adjust the RESOLUTION for a pulse signal, set the oscilloscope sweep rate for a pulse repetition frequency of about 40 lines in the principal lobe of the spectrum. Then, adjust the RESOLUTION control for well-defined lobe zeros without ringing (see Fig. 2-6). This setting corresponds to a bandwidth-pulse width product of 0.1 or less.

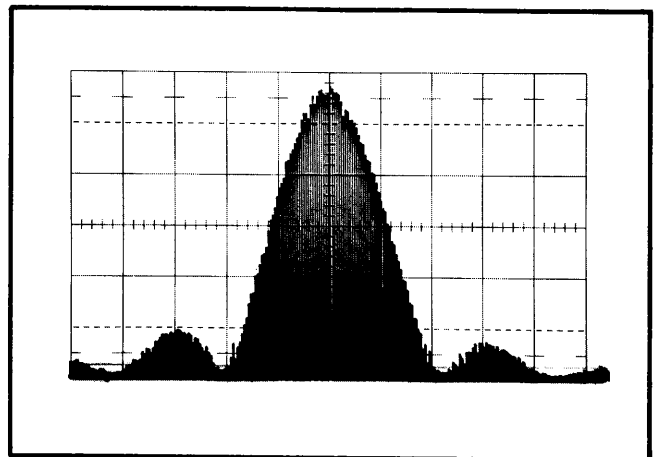

Fig. 2-6. Display of the frequency spectrum of a pulsed cw signal.

Relative Amplitude Measurements

The relative amplitudes of two signals can be measured as follows:

1. Center the IF CENTER FREQ controls.
2. Tune the smallest-amplitude signal to the center of the screen, using the RF CENTER FREQ control.
3. With all of the IF ATTN switches OFF, adjust the GAIN control for exactly 4 centimeters of vertical deflection of the smallest signal.
4. Tune the larger-amplitude signal to the center of the screen.
5. Switch in as many IF ATTN switches as are required to make the larger-amplitude signal exactly 4 centimeters high.
6. Add the settings of the IF ATTN switches that were switched in. The total is the relative amplitude difference, in dB, between the two signals.

NOTE

For maximum accuracy, the two signals being compared should be referenced to the same place on the screen by changing the RF CENTER FREQ control only, since the IF bandpass response is not absolutely flat, but can vary as much as ± 1.5 dB. The IF CENTER FREQ, DISPERSION-COUPLED RESOLUTION, FINE FREQ, and sweep speed controls should not be moved while comparing the two signals.

Absolute Frequency Measurements

Absolute frequency measurements can be made from the RF CENTER FREQ dial with an accuracy of ± 2 MHz + 1% of the dial reading. To measure the frequency of an applied signal, proceed as follows:

1. Check the setting of the IF CENTER FREQ CAL adjustment and HORIZONTAL POSITION controls as directed on page 2-3.
2. Set both IF CENTER FREQ controls and the FINE FREQ control to midrange (000).
3. Set the DISPERSION RANGE switch to kHz/CM.
4. Set the DISPERSION switch to 500.
5. Move the signal being measured to the exact center of the graticule using the RF CENTER FREQ CONTROL.
6. Read the frequency indicated by the RF CENTER FREQ dial. For example, with a dial reading of 100 MHz, the actual signal frequency is 100 MHz ± 3 MHz (i.e., 2 MHz + 1% of 100 MHz = 3 MHz). For a dial reading of 1000 MHz, the actual signal frequency is 1000 MHz ± 12 MHz. (i.e., 2 MHz + 1% of 1000 MHz = 12 MHz.)

Frequency Difference Measurements

Frequency separation measurements can be made between signals that are up to 100 MHz apart. The measurement is made as follows:

1. With the two signals displayed on the screen, set the DISPERSION RANGE and DISPERSION switches so that the signals are spaced as far apart on the screen as possible. (Center the two signals on the screen each time the DISPERSION switch is set to a lower position.)
2. Set the sweep rate of the oscilloscope and the RESOLUTION control of the Type 1L20 for the best defined signal peaks.
3. Measure the distance in graticule divisions between the two signals (see Fig. 2-7).
4. Multiply the distance measured in step 3 by the DISPERSION/CM setting to determine the frequency separation. For the example of Fig. 2-7,

$$f_s = (7 \text{ cm}) (2 \text{ MHz/cm}) = 14 \text{ MHz}$$

5. Accuracy of the measurement will vary according to the DISPERSION and DISPERSION RANGE settings. See Table 1-2.

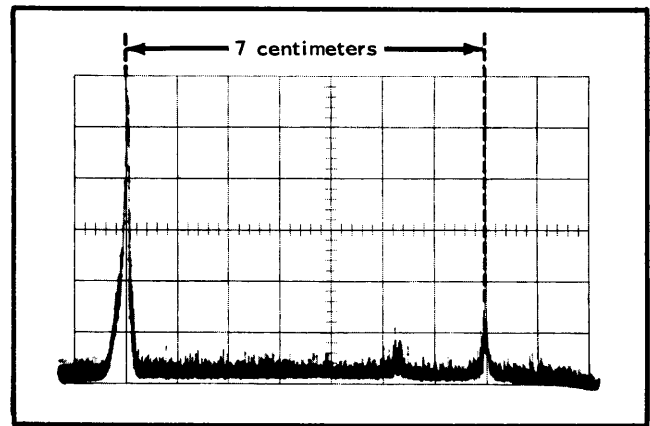

Fig. 2-7. Frequency difference measurement between two signals. DISPERSION RANGE setting = MHz
DISPERSION setting = 2

Frequency Spectra Measurements of Pulsed Signals

The main frequency lobe and side lobes of a pulse-modulated signal can be displayed and used to measure the pulse width as follows:

1. Adjust the DISPERSION—COUPLED RESOLUTION control and the RF CENTER FREQ Control so that the main frequency lobe of the displayed signal is in the approximate center of the graticule and the side lobes of interest are visible. (See Fig. 2-8.)

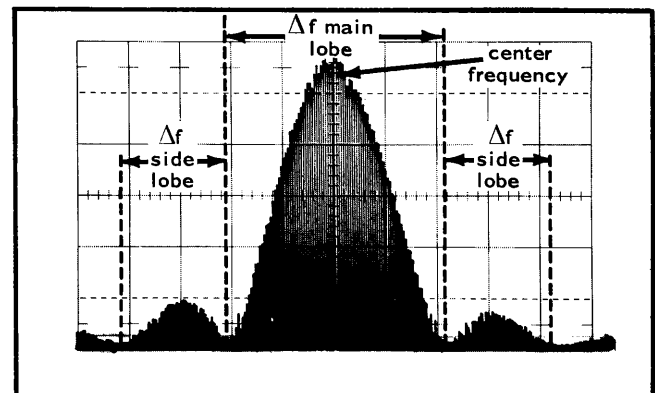

Fig. 2-8. Spectrum for a square RF pulse.

2. Set the GAIN control and the IF ATTEN switches so that the main lobe fills the screen vertically and the side lobes are of sufficient amplitude for viewing.
3. Set the sweep rate of the oscilloscope so the spectrum is well defined (Sweep Rate = 1/50 pulse repetition rate).
4. Set the RESOLUTION control so that the low points in the spectrum are easily discernible without excessive loss of sensitivity. (Changing the VERTICAL DISPLAY Mode—LOG, LIN, or SQ LAW—may make these points easier to see.)

5. The equivalent pulse width of the modulation signal can now be determined by measuring the frequency width (see Fig. 2-8) of either the main lobe (Δf_{main}) or a side lobe (Δf_{side}) as directed in Frequency Difference Measurements on page 2-8 and calculating for pulse width:

$$t = \frac{2}{\Delta f_{\text{main}}} \quad \text{or} \quad t = \frac{1}{\Delta f_{\text{side}}}$$

where:

- t = pulse width in microseconds
- Δf_{main} = frequency width of main lobe in MHz
- Δf_{side} = frequency width of side lobe in MHz

Repetition Rate Measurements of Pulsed Signals

The spectrum analyzer can also be used to measure the repetition frequency of the pulsed signal. Note in Fig. 2-8 the frequency distribution for the pulsed signal is a series of vertical lines. Each line represents one sampling (interception) of a pulse during the sweep interval. Thus, at zero dispersion, the line spacing will correspond directly to the sweep time.

The pulse rate can therefore be determined directly from the number of lines per division when the sweep speed is known. The procedure to be followed is given below:

1. Set the RF CENTER FREQ and the IF CENTER FREQ controls so that the signal appears at the center of the screen.
2. Set the DISPERSION switch to 0 and set the DISPERSION RANGE switch to kHz/CM. The oscilloscope is now operating as a time-base oscilloscope, and each line on the

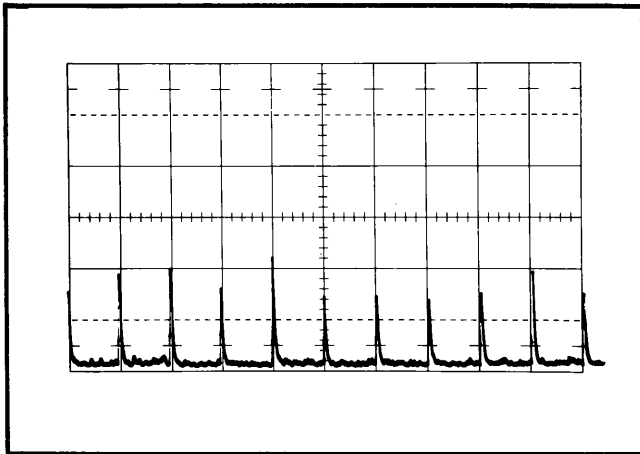

Fig. 2-9. Pulse repetition rate measurement: 50 $\mu\text{S}/\text{CM}$ sweep.

screen is equivalent to one pulse. (It might be helpful if the RESOLUTION control is uncoupled and reset for better resolution.)

3. Set the sweep controls of the oscilloscope for +INT triggering and set the Stability and Trig Level controls for a stable trace.

4. Set the Time/CM switch of the oscilloscope to display several pulses of the applied signal (see Fig. 2-9). Be sure the Variable Time/CM control of the oscilloscope is in the Calibrated position.

5. Count the number of lines (pulses) in one or more divisions and use the oscilloscope sweep rate to compute the time between each pulse. In the example of Fig. 2-9, the pulse repetition rate is:

$$\frac{(1 \text{ cm}) 50 \mu\text{s}/\text{cm}}{1 \text{ pulse}} = \frac{50 \mu\text{s}}{\text{pulse}} = 20 \text{ kHz}$$

Use of Expanded Sweep

The expanded (magnified) sweep can be used to advantage in certain spectrum analyzer measurements. It is often desired to examine a very small portion of the display in more detail. Theoretically, such an examination could be performed by changing the DISPERSION—COUPLED RESOLUTION control to give the desired display. A faster and easier method may be to set that part of the display to be examined to the center of the screen and expand the sweep.

Fig. 2-10 shows an expanded display of the pulsed RF signal that was shown in Fig. 2-8. The spectrum is being examined in detail in the vicinity of one of the nulls.

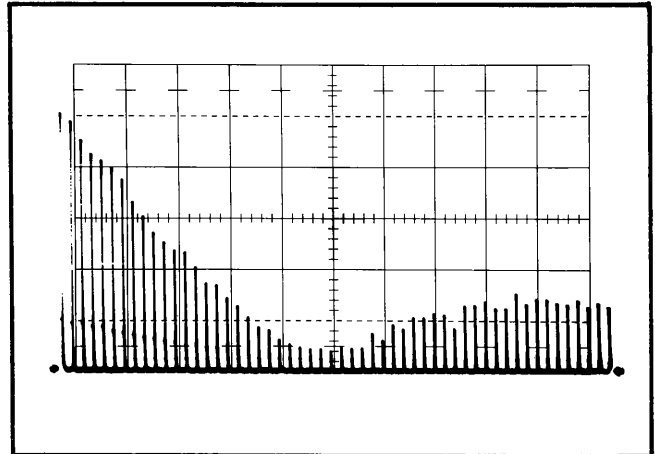

Fig. 2-10. $\times 5$ magnification applied to the display shown in Fig. 2-9.

SECTION 3

CIRCUIT DESCRIPTION

General Description

The Type 1L20 Spectrum Analyzer is a superheterodyne receiver that is electronically tuned over a portion of the frequency spectrum at a rate synchronized with the horizontal sweep of the oscilloscope. In the resulting display, horizontal deflection on the CRT is proportional to frequency, with the vertical deflection proportional to the signal strength.

In the block diagram and the detailed-circuit description that follow, the numbered diamonds () indicate the schematic diagram showing that part of the circuit.

BLOCK-DIAGRAM DESCRIPTION

Figure 3-1 is a block diagram of the Type 1L20 Spectrum Analyzer.

A signal connected to either RF INPUT connector is converted to an IF signal centered at 200 MHz by means of the RF Mixer and Local Oscillator for that input circuit. The Local Oscillators can be locked to harmonics of a stable reference frequency by the Phase Lock circuit to help eliminate undesirable frequency modulation and drift in the Local Oscillator output frequency.

The 200 MHz IF signal from the first mixer is then sent through one or two low-pass filter networks to eliminate spurious signals generated between the L.O. and the Sweeper Oscillator, amplified in the Wide-Band IF Amplifier, and mixed with the Swept Oscillator signal being swept in synchronism with the time base of the oscilloscope.

The resulting 75 MHz signal is further amplified in the second IF amplifier stage, converted to a 5 MHz third IF, and amplified in a variable bandwidth (1-100 kHz) 5 MHz IF amplifier which determines the system resolution. After amplification and detection, the signal is applied to the vertical amplifier of the oscilloscope.

RF Tuner and Phase Lock Circuits

Local Oscillator Circuit

The RF Tuner section of the Type 1L20 contains two Local Oscillators. The basic difference between the two is in their frequency range; each local oscillator is a tuned circuit triode oscillator gang-tuned by the RF CENTER FREQ control. The RF INPUT switch SW40—SW70 supplies the B+ voltage to only one local oscillator at a time to prevent undesirable radiation from the one not in use, and connects the correct mixer to the Intermediate Frequency system.

Band 1 operates on the fundamental frequency of the 210 MHz—475 MHz Local Oscillator; Bands 2, 3, 4, and 5 use the fundamental frequency and the second, third and fourth harmonics respectively of the 475 MHz—1100 MHz Local Oscillator.

Phase Lock Circuit

The Phase Lock circuit synchronizes the Type 1L20 Local

Oscillators with a stable reference frequency so that the LO stability approaches that of the reference frequency. This allows the use of very narrow dispersion settings where the Type 1L20 would be limited otherwise by such factors as oscillator drift and microphonics.

The instantaneous RF voltage being generated by the Local Oscillator is sampled by the Phase Detector at a rate determined by the reference frequency. The resulting signal is amplified and fed back to a varactor in the Local Oscillator.

The same signal is connected to the vertical system of the oscilloscope when the LOCK CHECK switch is closed to provide a means of checking the action of the circuit. If the LOCK CHECK switch is held in while the Local Oscillator is being tuned by the RF CENTER FREQ control, beat frequencies will appear on the CRT as the LO frequency approaches a multiple of the reference frequency. When the LO is tuned to an exact multiple of the reference signal, a zero beat occurs and the LO will be locked in phase with the reference frequency.

The reference frequency (either the internal 1 MHz signal from Q800—Y800 or the external REF FREQ IN signal) is converted to a train of positive trigger pulses by the Trigger Generator circuit of Q820. Q820 is a blocking oscillator which is quiescently turned on by a forward bias in its base circuit. As the input signal goes negative, D821 (in series with the base) turns on, pulling the base down. The emitter follows the base down, reducing the current in transformer T820. T820 increases the action in the base circuit of Q820, causing regeneration, and the transistor turns off in 2 to 3 nanoseconds. The third transformer winding of T820 couples the resulting positive-going trigger pulse through D841 to the base of the avalanche transistor Q840 to generate a fast negative-going spike at the collector.

The emitter follower Q830 in the collector circuit of the avalanche transistor sets the avalanche voltage. The fast-falling avalanche voltage is capacitively coupled to the snap-off diode D846, which is forward biased in its quiescent state. When the avalanche occurs, the diode presents a low impedance and its stored charge is swept out through the avalanche transistor Q840. When the stored charge is dissipated, a fast-recovery step results and is capacitively coupled to the transmission line transformers T851—T856. The output of each transformer is a series of equal-amplitude positive and negative-going impulses of very short duration and risetime.

These impulses, applied to the Phase Detector circuits, turn on the fast-recovery diodes for about 200 picoseconds (less than one-half of the highest Local Oscillator frequency). The average value of the oscillator signal voltage during the gated interval is added to each impulse. The two impulse voltages plus the oscillator signal voltage are applied across the resistors in the Phase Detector. Due to differential action, twice the oscillator signal (and no impulse voltage) appears as the Phase Detector output.

This error-signal voltage is integrated and amplified by Q860 and Q870 and fed to the Local Oscillator varactors,

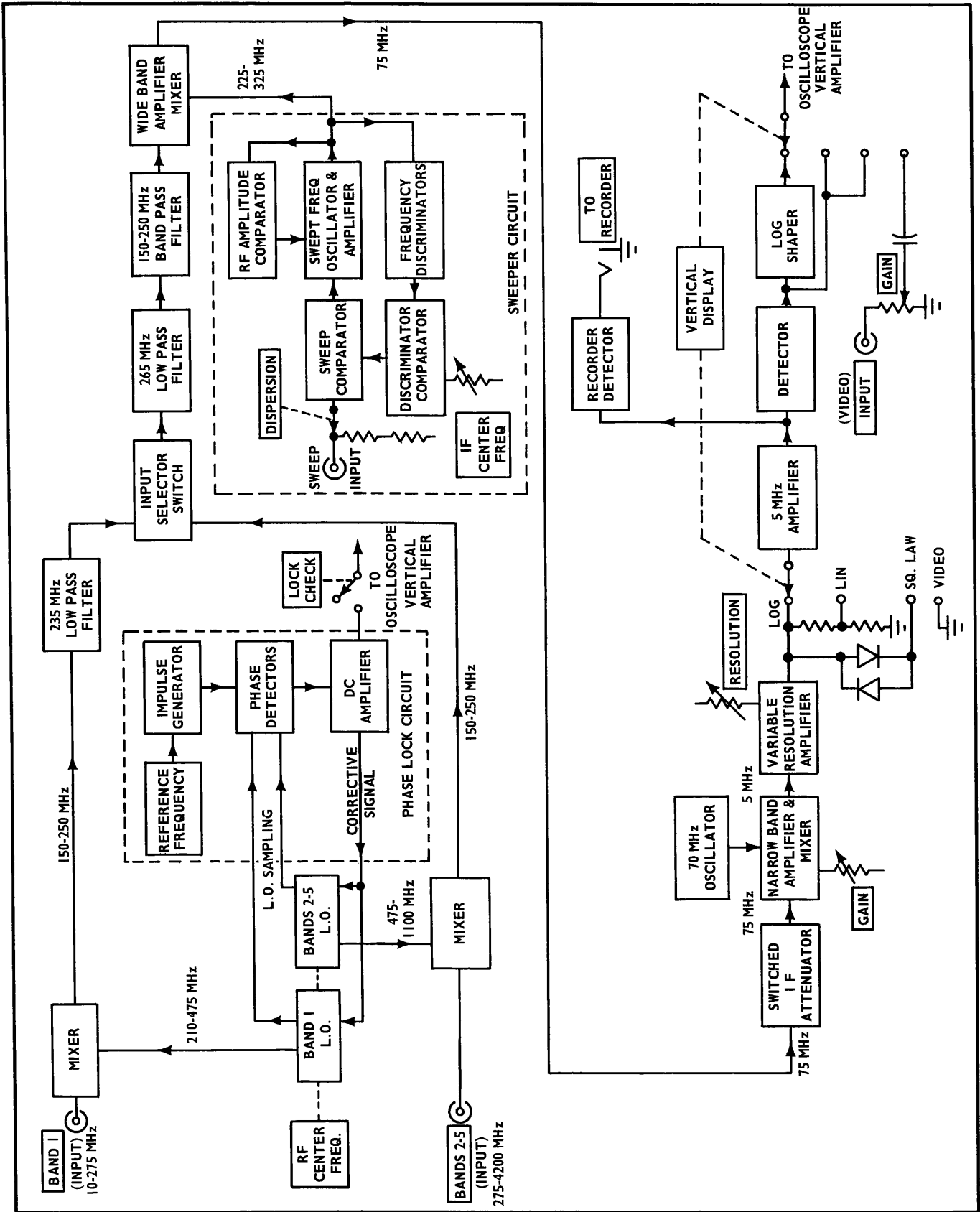

Fig. 3-1. Block Diagram of the Type 1L20.

thus correcting for any tendency of the LO to drift in frequency. The DC level of the corrective signal can be set by the FINE FREQ control R862 to provide a fine adjustment of the LO frequency.

The LOCK CHECK switch SW889 allows the output of the Phase Lock circuit to be connected to the input of the oscilloscope vertical amplifier so the beat frequency between the Local Oscillator and the reference signal may be viewed directly on the CRT. This amplitude-versus-time display is used to setup the Phase Lock circuit.

The output of the 1 MHz oscillator is connected to the front panel 1 MHz CAL MARKERS OUT connector for use in checking the dispersion calibration of the analyzer. By this means, the analyzers dispersion be recalibrated when it is moved from scope to scope.

Diode Mixer Circuits

Diode mixers are used to combine the RF input signal with the output from the Local Oscillator to produce a difference signal centered around 200 MHz.

The mixer for Band 1 uses a balanced circuit to minimize spurious signals generated by the mixing of the Local Oscillator output and the Swept Oscillator signal. With no applied signal and with C14 and C16 set for proper balance, the Local Oscillator signal is minimized at the junction of D14 and D16. This reduces spurious signals that might otherwise be produced by the Local Oscillator. When a signal is applied to the Band 1 RF Input connector, it disturbs the balance of the bridge circuit by alternately biasing the diodes in opposite directions. When this occurs, heterodyning takes place between the applied signal and the Local Oscillator signal.

The mixer for Bands 2-5 uses a peaking circuit to optimize the mixer action. Efficient mixer operation depends on the diode being properly biased, and is a function of the Local Oscillator drive, the desired harmonic conversion, and the series resistance in the diode loop. Since Bands 3, 4, and 5 use higher harmonics of the 475-1100 MHz oscillator, MIXER PEAKING control R66 has been added to the mixer of Bands 2-5. R66 controls the amount of bias and harmonic content of the rectified signal; therefore it is able to peak up the sensitivity of the mixer at the various harmonic frequencies being used.

Low Pass Filters

The output from the Band 1 mixer is passed through a 235 MHz low-pass filter to eliminate spurious signals caused by harmonic frequencies generated by the Local Oscillator mixing with the Swept Frequency Oscillator signals.

A second low-pass filter takes the output selected by the RF INPUT switch SW70 and further attenuates any frequencies above 265 MHz. This attenuation, along with that supplied by the following 150-250 MHz Bandpass Filter, suppresses signals in the image frequency band of the 200 MHz IF amplifier (300 MHz to 400 MHz).

Wide-Band 200 MHz Amplifier and Mixer

The output from the 265 MHz Filter is passed through the 150 MHz—250 MHz Bandpass filter mentioned above and amplified by the Wide-Band Amplifier Q120-Q130, a two-

stage common emitter IF amplifier tuned for a wide-band response centered around 200 MHz.

The signal from Q130 is combined in the amplifier-mixer stage of Q140 with the Swept-Frequency Oscillator signal coming from the Sweeper circuit to develop the difference frequency of 75 MHz. This signal is coupled through C147 and L147 to the IF attenuator. C145-L147 form a 65 MHz trap to suppress signals in the image band of the 5 MHz intermediate frequency.

Sweeper Circuit



The Sweeper generates a signal centered at 275 MHz but varying in frequency in step with the movement of the electron beam across the CRT. This swept-frequency signal is fed to the Wide-Band Mixer where it is mixed with the 200 MHz first IF signal as described above.

The sawtooth voltage from the oscilloscope is connected to the Analyzer SWEEP INPUT connector by an external jumper cable. This sawtooth voltage is attenuated by an amount determined by the setting of the Sawtooth Selector switch SW201 and applied to the attenuation network of the DISPERSION switch SW220. The front-panel DISP CAL adjust sets the amplitude of the sawtooth voltage appearing across the DISPERSION switch and is used to calibrate the MHz/CM DISPERSION range. The internal Swp Ctr adjustment R204 sets the DC level of the sawtooth to center the sweep at 0 volts. The DISPERSION switch selects (in a 1-2-5 sequence) the amplitude of the sweep sawtooth applied to the input of the Sweep Comparator circuit at Q230.

The Sweep Comparator circuit compares this sawtooth signal with a feedback signal coming from the output of the Swept-Frequency Oscillator circuit. An error signal is sensed, amplified, and sent on to bias D314, a variable-capacitor diode forming the major part of the capacitance of the resonant circuit of the Swept Frequency Oscillator. This error signal will be of such a nature that its non-linear characteristics will cancel the effect of the non-linear characteristics of the diode. As a result, the output of the Swept Frequency Amplifier will be a signal that changes in frequency at a very nearly linear rate.

The capacitance change in D314 is not directly proportional to the voltage change across it, but instead varies more or less as an exponential function of the applied voltage. The frequency-discriminator feedback loop has been added to correct for this non-linearity.

A separate frequency discriminator circuit is provided for each dispersion range. In the kHz/CM circuit, the two resonant circuits (L384-C384 and L385-C385) are tuned to slightly different frequencies, centered at 275 MHz, as shown in Figures 3-2A and 3-2B. When the output of the detectors (D373 and D376) is applied to the Discriminator Comparator circuit of Q260, the result is a voltage versus frequency curve similar to Fig. 3-2C. The circuit operates on the central linear portion of the curve.

The MHz/CM Discriminator is a transmission-line type. One line is open-circuited and thus has the capacitive characteristic of a tuned circuit operating above its resonant frequency. The other is shorted and thus has the inductive characteristic of a tuned circuit operating below its resonant frequency. Each transmission line is $\frac{1}{8}$ wavelength long at the

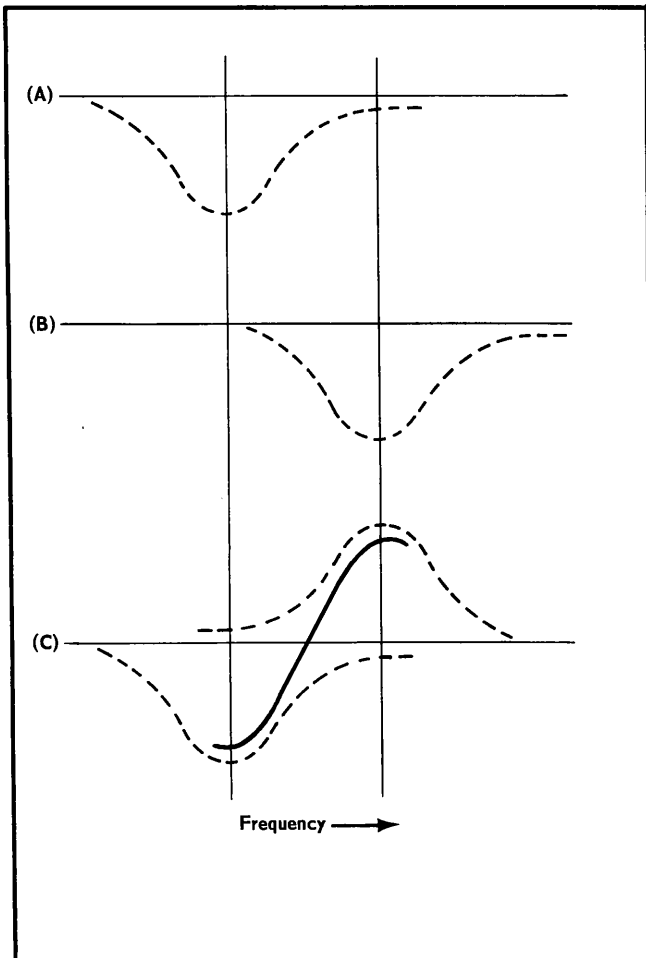

Fig. 3-2. Frequency vs. Voltage curves for kHz/CM Discriminator circuit.

- (A.) Output from D383;
- (B.) Output from D386;
- (C.) Output from Discriminator Comparator Q260.

center of the operating range (275 MHz). This type of discriminator is used because of the wide (100 MHz) frequency coverage needed. The kHz/CM Discriminator has better stability than the line type, but covers only 10 MHz.

In the Discriminator Comparator circuit of Q260, the detected outputs of the Frequency Discriminator are compared and the difference signal is sensed, amplified, and sent on to the Sweep Comparator as has already been described. IF CENTER FREQ controls R270 and R274 provide a means of controlling the center frequency of the display by adjusting the DC level of the feedback signal going to Q240.

The filter circuit of C358-L358 adjusts the linearity of the MHz/CM display by attenuating some of the high-frequency components of the Swept-Frequency signal. R368 adjusts the impedance of D365 to set the slope of the kHz/CM Discriminator at twenty times the slope of the MHz/CM Discriminator.

The output amplitude of the Sweeper circuit must be kept constant for proper action of the discriminator circuit and for

proper mixing action in the Wide-Band Mixer Amplifier Q140. This has been accomplished by the feedback loop through D361, Q280, and Q290. The amplitude of the swept-frequency signal is detected by D361. This voltage amplitude is compared to the fixed DC voltage at the IF Center Freq Range control R290. The resulting difference signal from the Amplitude Comparator circuit of Q290-Q280 is used to bias the base of Q320 to control the current supplied to the Swept-Frequency Oscillator Q310.

The swept frequency signal is amplified by the push-pull amplifier circuit of Q340-Q350, converted to a single-ended signal by T347, filtered, and coupled to the 200 MHz Wide-Band Mixer through T363 and J363.

IF Attenuator

5

The IF Attenuator is a six-section pi attenuator giving a total attenuation of 51 dB (355:1 voltage attenuation) in 1 dB steps. The attenuator maintains a constant 50 Ω input and output impedance regardless of the IF ATTENUATOR switch settings. Low pass filters (C151-L151-C152 and C187-L188-C188) have been added to the input and output circuits of the attenuator to prevent harmonics from the following 70 MHz Oscillator from feeding back to mix with the Swept-Frequency (Sweeper) Oscillator signal to generate spurious signals.

Narrow-Band IF Amplifier

6

The Narrow-Band IF Amplifier circuit includes a two-stage 75 MHz Amplifier, a crystal controlled 70 MHz Local Oscillator, and a two-stage 5 MHz Amplifier.

The 75 MHz IF Amplifier Q420 and Q430 is a conventional two-stage common-emitter transformer-coupled amplifier. Both stages are peaked to 75 MHz—by C425 for the first stage, and by C435 for the second stage. GAIN control R411A varies the gain of both stages by changing the DC bias. Negative feedback through C422 neutralizes the first stage to keep it from oscillating.

The outputs of the 75 MHz IF Amplifier and the 70 MHz Oscillator are applied to the base of the mixer-amplifier Q450, which amplifies the difference frequency (5 MHz) of the two input signals. T454 of the mixer stage is tuned to 5 MHz, and couples the narrow-band signal to the base of Q460. This amplifier is peaked at 5 MHz by T464. The signal is coupled through T464 to the Variable Resolution Amplifier,

Variable Resolution Amplifier

7

Crystal Filter Circuit

The signal from the secondary of T464 is coupled to the 5 MHz crystal filter Y501. To understand how this circuit operates, consider the impedance characteristic of the crystal. Fig. 3-3 shows a typical impedance versus frequency curve of a crystal.

In examining the curve from left to right, we first encounter a very low impedance point (a) at the series-resonant frequency. As the frequency increases, the impedance increases

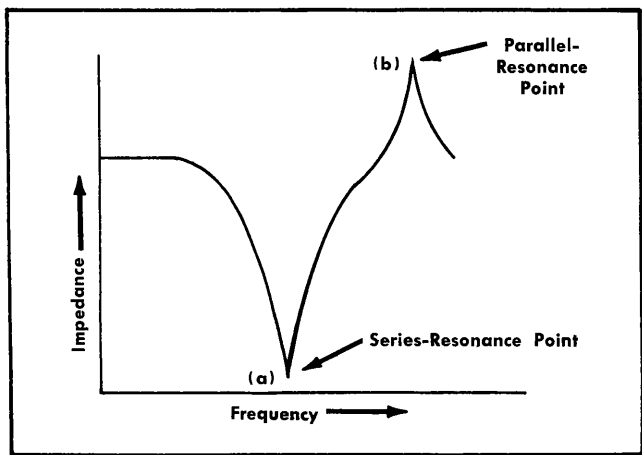

Fig. 3-3. Typical impedance vs. frequency graph of a crystal. Note the series-and-parallel-resonance points.

to a sharp peak (b) at the parallel-resonance frequency. Then the impedance drops fairly abruptly because of the parallel shunt-capacitance of the crystal and its mounting.

If this parallel capacitance is cancelled, the impedance of the crystal exhibits the impedance-versus-frequency curve shown in Fig. 3-4.

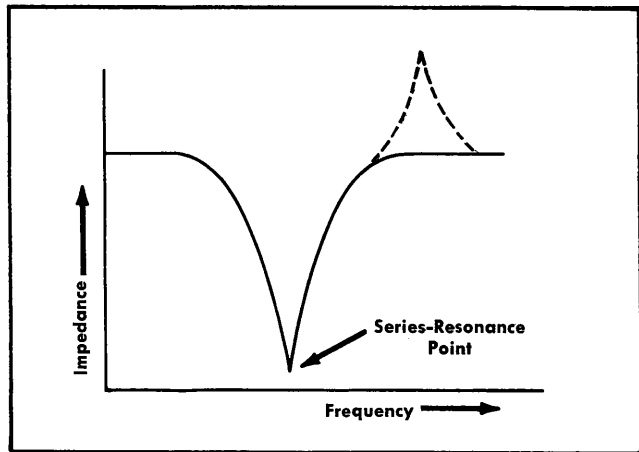

Fig. 3-4. Impedance vs. frequency graph of a crystal when parallel capacitance is cancelled.

This cancelling of the shunt capacitance of the crystal and its holder is accomplished by the series capacitance C504 (see Fig. 3-5). Since the voltage at the bottom end of the secondary of T464 (Fig. 3-5) is opposite in phase to the voltage on the top end, the capacitive reactance introduced by C504 will directly subtract from the shunt X_c of the crystal. Hence, with C504 properly adjusted, Y501 exhibits no parallel resonance and assumes the impedance-versus-frequency curve of Fig.3-4.

Variable Resolution Filter

The resolution of the spectrum display is determined by the series resonant circuit of Y501, L508, and C508. When

lightly loaded, the frequency response of the circuit will be much broader than the response of the crystal alone, giving a wide bandpass (low resolution) display. When the RESOLUTION control SW550 is turned counterclockwise (toward +100 volts), the increase in forward bias on D506 increases the loading on the series resonant circuit, thus lowering the Q of the L508-C508 tank circuit. As a result, the crystal's sharp cutoff characteristic becomes the determining factor, resulting in a high-resolution display.

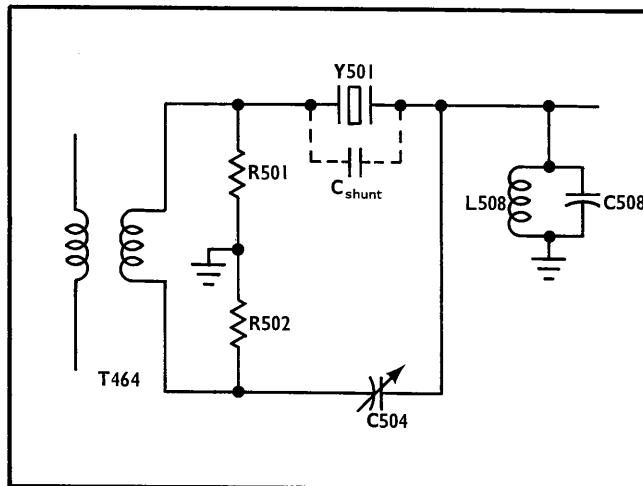

Fig. 3-5. Shunt-capacitance cancelling circuit for Y501.

R543 is adjusted to set the resolution at 100 kHz with the RESOLUTION control at the clockwise end of its rotation. The other positions of the RESOLUTION control are not calibrated, although the resistance of each step of the voltage divider has been chosen so that the resolution of the display will be near optimum for most displays when the RESOLUTION control is coupled to the DISPERSION control.

Since the variable resolution circuit cannot be coupled directly to a low-impedance load, it is followed by emitter followers Q510 and Q520 to isolate the high impedance of the filter from the relatively low input impedance of the following amplifier Q530.

Variable Resolution Amplifier

Q530 is a common emitter amplifier which provides the increased signal amplitude required to operate the LOG and SQ LAW circuits of the Output Amplifier.

Output Amplifier



5 MHz Amplifier and Detectors

The signal from the Variable Resolution Amplifier is connected to the input section of the Vertical Display switch SW660.

In the LOG position of SW660, there is no attenuation of the signal in the input section of the amplifier. This straight-through coupling of the signal provides the full 40 dB dynamic range required for LOG display.

Circuit Description—Type 1L20

In the LIN position of the switch, the R606-R607 voltage divider attenuates the input signal by approximately 3 to 1 so that a signal giving a full-screen display in LIN position will continue to give a full-screen display when the switch is moved to one of the other positions.

In the SQ LAW position, the signal is coupled through two germanium diodes (D603 and D604) connected back to back and in series with R610 to form a voltage divider. To illustrate the action of the SQ LAW divider, Fig. 3-6A shows the current-versus-voltage characteristic curve for the back to back diodes. Fig. 3-6B shows the diodes dynamic resistance curve derived from Fig. 3-6A. Note that for very low millivolt signals, the diode resistance exceeds 100 k Ω . As a result, the divider ratio of 100:1 at 60 millivolts will pass about 1% of the signal; at 160 millivolts the divider ratio will be about 2:1 and 50% of the signal will pass. Since the circuit will normally operate with signal levels about 70 millivolts for a full-screen display, the diodes will usually be operating along the steep portion of the resistance curve.

The non-linear dynamic resistance of the diodes results in a display that emphasizes small differences between similar signals. The vertical response of the SQ LAW display will be approximately proportional to the signal power.

In the VIDEO position of SW660, the spectrum display signal is grounded to prevent it from interfering with a signal connected to the VIDEO INPUT connector.

The signal from the VERTICAL DISPLAY switch is coupled through T610 to the 5 MHz crystal filter Y610, which is similar in action to Y501 with C610 cancelling out the shunt capacitance around Y610. However, unlike Y501, Y610 operates with a fixed bandpass. Filter C620-L620 helps shape the 100 kHz response and suppresses spurious responses generated by Y610.

V620 and Q650 further amplify and isolate the 5 MHz signal before it is detected by D657 for the TO RECORDER output and by D660-D661 for the CRT display.

Video Filter

The VIDEO FILTER switch SW661 places C661 across the output of D660 to limit the high frequency response of the detector circuit.

Vertical Display Switching

In the LIN and SQ LAW positions of the VERTICAL DISPLAY switch, the signal is attenuated 2:1 by R662 and R663 before being connected through Pin 1 of the output connector P11 to the Vertical Amplifier circuits of the oscilloscope.

In the LOG position, the signal also passes through an attenuator before going to the output connector. The LOG attenuator is made up of R664 in series with silicon diodes D664 and D665. The silicon diodes in this circuit behave close to the ideal that voltage differences are proportional to the logarithm of the current applied. R664 converts the detector input voltage to current for this circuit. R665 helps suppress the small current-voltage offset of the silicon diodes to make the attenuator more nearly logarithmic. R666 (Log Cal) sets the maximum amplitude of the LOG display to slightly exceed the graticule limits.

In the VIDEO position, the VERTICAL DISPLAY switch connects the VIDEO INPUT connector to the output connector P11 through C668 and GAIN control R411B.

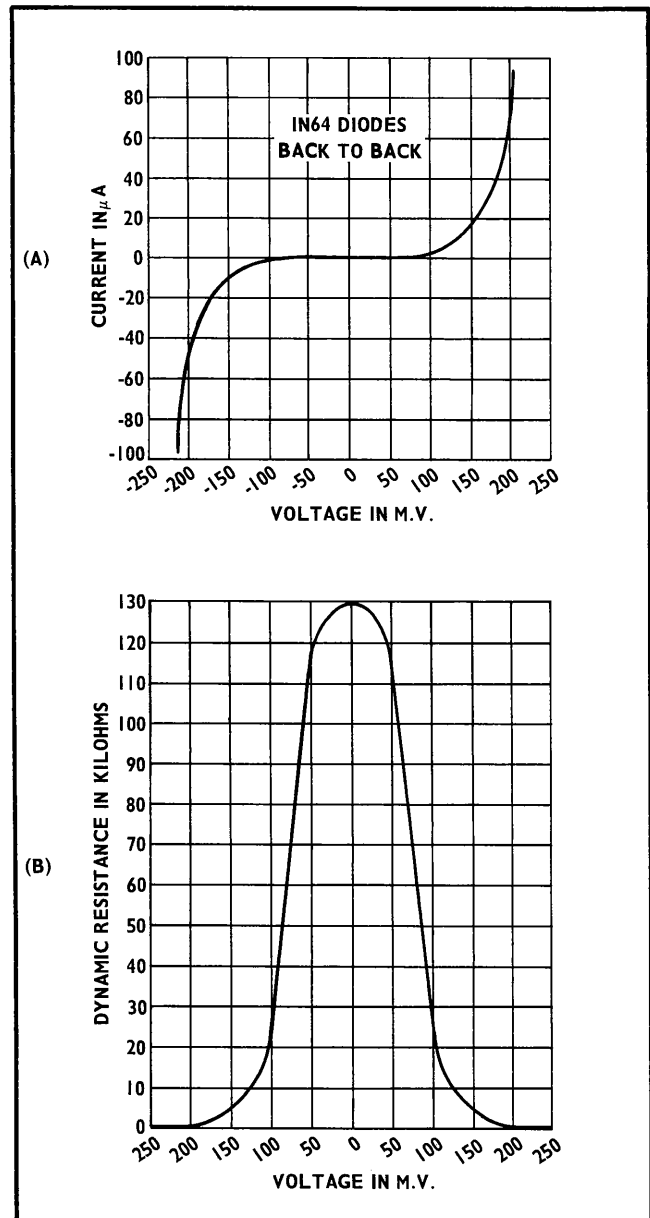

Fig. 3-6. Characteristic Curves for 1N64 Diodes:
(A.) Voltage vs. Current;
(B.) Voltage vs. Dynamic Resistance.

Vertical Positioning

The spectrum display and the VIDEO INPUT circuits are isolated from DC ground by the coupling capacitors C660 and C668. This allows the POSITION control network to set the DC reference level of the output circuits.

Lock Check Circuit

The LOCK CHECK switch SW889 allows the output of the phase-lock circuitry to be connected to the input of the vertical amplifier so the beat frequency signal may be viewed directly on the CRT.

SECTION 4

MAINTENANCE

Introduction

This section of the manual contains maintenance information for use in maintenance and troubleshooting on the Type 1L20. The early part of the section deals with general maintenance. This is followed by general information on corrective maintenance and ordering of replacement parts, then finally by detailed information on difficult repair and replacement procedures.

PREVENTIVE MAINTENANCE

General

Preventive maintenance consists of cleaning, visual inspection, lubrication, and if needed, recalibration. Preventive maintenance is generally more economical than corrective maintenance, since preventive maintenance can usually be done during idle periods at a time convenient to the user. The preventive maintenance schedule established for the instrument should be based on the amount of use and on the environment in which the instrument is used.

Cleaning

The Type 1L20 should be cleaned as often as operating conditions require. Accumulation of dirt in the instrument can cause overheating and component breakdown. Dirt on components acts as an insulating blanket and prevents efficient heat dissipation. It also provides an electrical leakage path.

CAUTION

Avoid the use of chemical cleaning agents which might damage the plastics used in this instrument. Some chemicals to avoid are benzene, toluene, xylene, acetone or similar solvents.

Exterior

Loose dust accumulated on the front panel of the instrument can be removed with a soft cloth or small paint brush. The paint brush is particularly useful for dislodging dirt and dust around the front-panel controls. Dirt which remains can be removed with a soft cloth dampened in a mild solution of water and detergent. Abrasive cleaners should not be used.

Interior

Due to its electrical conductivity under high-humidity conditions, dust in the interior of the instrument should be removed occasionally. The best way to clean the interior is to blow off the accumulated dust with dry, low-velocity air. (High-velocity air can damage some components.) Remove any dirt which remains with a soft paint brush or a cloth dampened with a mild detergent and water solution. A cotton-tipped applicator is useful for cleaning in narrow spaces or for cleaning ceramic terminal strips.

Lubrication

The life of the rotary switches will be lengthened if these devices are kept properly lubricated. Use a cleaning type

lubricant (such as Cramoline) on shaft bushings, plug-in connector contacts, and switch contacts. Lubricate the switch detents with a heavier grease (Beacon No. 325 or equivalent). The necessary materials and instructions for proper lubrication of Tektronix instruments are contained in a component lubrication kit which may be ordered from Tektronix. Order Tektronix Part No. 003-0342-00.

Visual Inspection

The Type 1L20 should be inspected occasionally for such defects as broken connections, broken or damaged ceramic strips, improperly seated vacuum tubes or transistors, and heat-damaged parts. Care must be taken if heat-damaged parts are located. Overheating is usually a symptom of other troubles. For this reason, it is essential to determine the actual cause of the trouble; otherwise the damage may be repeated.

Tube and Transistor Checks. Periodic preventive maintenance checks consisting only of removing the tubes and transistors from the instrument and testing them in a tester are not recommended. The circuits within the instrument provide the only satisfactory means of checking tube and transistor performance. Defective tubes or transistors will usually be detected during recalibration of the instrument. Details of in-circuit tube and transistor checks are given in the troubleshooting procedure later in this section.

Performance Checks and Recalibration

To insure accurate measurements, the instrument performance should be checked after each 500 hours of operation or every six months if the instrument is used intermittently. The calibration procedure is helpful in isolating major troubles in the instrument. Moreover, minor troubles not apparent during regular operation are frequently revealed and corrected during recalibration. Performance Check instructions are given in Section 5; Calibration instructions are given in Section 6.

CORRECTIVE MAINTENANCE

General

Corrective Maintenance consists of component replacement and instrument repair.

NOTE

If the dial error on Band 1 or Band 2 exceeds ± 2 MHz $+1\%$ of the dial reading, the instrument should be returned to the factory for repair and/or calibration. Local Oscillator and dial tape calibration procedures have been included at the end of Section 6, but should be used only if the instrument cannot be returned to the factory. Because of the interaction between the adjustments, it will usually be more satisfactory (and more economical) to have the Local Oscillator recalibrated by our factory technicians.

Obtaining Replacement Parts

Standard Parts. All electrical and mechanical part replacements for the Type 1L20 can be obtained through your local Tektronix Field Office or representative. However, many of the standard electronic components can be obtained locally in less time than is required to order them from Tektronix, Inc. Before purchasing or ordering replacement parts, consult the Parts List for value, tolerance, and rating.

When selecting replacement parts, it is important to remember that the physical size and shape of the component may affect its performance at high frequencies. All replacement parts should be direct replacements unless it is known that a different component will not adversely affect instrument performance.

Ordering Parts. When ordering replacement parts from Tektronix, include the following information:

1. Instrument Type.
2. A description of the part (if electrical, include circuit number).
3. Tektronix Part Number.
4. Instrument Serial Number.

Component Numbering

The circuit number of each electrical part is shown on the circuit diagrams. Note that a functional group of circuits (such as the RF Section) is assigned a particular series of numbers. Table 4-1 lists the component numbers as they are assigned to the functional grouping of circuits.

TABLE 4-1
Component Numbering

Component No. Series		Circuit
1-99	RF Section	1
100-149	Wide-Band Amplifier & Mixer	3
150-199	IF Attenuator	5
200-399	Sweeper Circuit	4
400-499	Narrow-Band Amplifier	6
500-560	Variable-Resolution Amplifier	7
600-727	Output Amplifier	8
800-890	Phase Lock Circuit	2

Resistor Coding

The Type 1L20 uses a number of metal film resistors identified by their gray background color and color coding.

If the resistor has three significant figures with a multiplier, the resistor will be EIA color-coded. If it has four significant figures with a multiplier, the value will be printed on the resistor. For example, a 333 kΩ resistor will be color coded, but a 333.5 kΩ resistor will have its value printed on the resistor body.

The color-coding sequence is shown in Fig. 4-1.

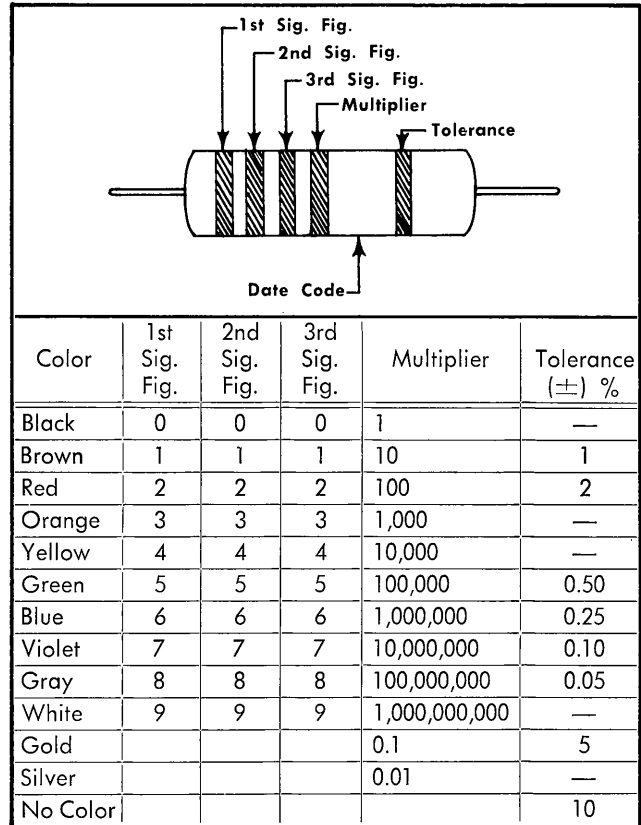

Fig. 4-1. Standard E/A Color-coding of metal-film resistors.

Wiring Color-Code

All insulated wire used in the Type 1L20 is color-coded according to the EIA standard color-code to facilitate circuit tracing. The widest color stripe identifies the first color of the code. Power supply voltages can be identified by three color stripes and the background color. White background color indicates a positive supply, and a tan background is used to indicate a negative supply. Table 4-2 shows the wiring color code for the power supply voltages used in the Type 1L20. The remainder of the wiring in the instrument is color coded with two or less stripes or has a solid background with no stripes. The color coding helps to trace a wire from one point in the instrument to another.

TABLE 4-2
Wiring Color-Code

Supply	Back-ground Color (Polarity)	1st Stripe (1st No.)	2nd Stripe (2nd No.)	3rd Stripe (Multiplier)
−10 V	Tan	Brown	Black	Black
+10 V	White	Brown	Black	Black
−75 V	White	Violet	Green	Black
+100 V	White	Brown	Black	Brown
−150 V	Tan	Brown	Green	Brown
+225 V	White	Red	Red	Brown
+350 V	White	Orange	Green	Brown

Removing and Remounting the IF Chassis

1. Loosen the front set-screw on the DISPERSION RANGE switch shaft with a .05 inch Allen wrench and slide the shaft out through the front panel.

2. Remove the two screws securing the DISPERSION RANGE switch to the rear plate and swing the switch assembly out of the way behind the rear plate.

3. Remove the fourteen Phillips head screws fastening the IF chassis to its base.

4. Swing the chassis up and out to rest on the instrument's spacer bars (See Fig. 4-2). (It may be necessary to disconnect the coaxial cable from J147.) Do not use force, because some of the parts are critically positioned and should not be moved out of adjustment.

5. Before turning on the power, check to make sure that none of the terminals and tie points are shorted or grounded. Also, reconnect any cables or wires that were disconnected. The ground-wire on the DISPERSION RANGE switch must be grounded for proper operation of the instrument.

6. Remount the IF chassis using the reverse of the procedures of steps 1 through 5. Do not force the chassis into place and check the wiring and connectors to prevent pinching and straining of the connections. When replacing the DISPERSION RANGE switch, be sure its shaft is properly coupled to SW365. Also check the operation of the DISPERSION RANGE switch to be sure the knob is properly indexed.

Removing the Phase-Lock Assembly

1. Turn off the power.

2. Unplug all the leads connected to the phase-lock assembly.

3. Use a $\frac{1}{16}$ inch Allen wrench to remove the FINE FREQ control knob.

4. Use a $\frac{5}{16}$ inch nutdriver to remove the nut securing the rear end of the phase lock assembly to the main chassis, and the nuts securing the front-panel phase-lock controls.

IMPORTANT

Keep the nut securing the INT 1 MHz REF FREQ switch separate from the others. It has a slightly different thread and will bind if it is placed on the wrong control.

5. Remove V260 (next to the square pin connectors).

6. Slide the phase-lock assembly back and toward V620 socket until the control shafts are clear of the front panel.

7. Remove the six Phillips head screws located along the edge of the "U"-shaped phase-lock cover and slide out the assembly. Be careful that the low-pass filter mounting screws on the cover do not catch on the chassis.

8. If you expect to turn on the power with the assembly removed, replace V620, the three control nuts you removed

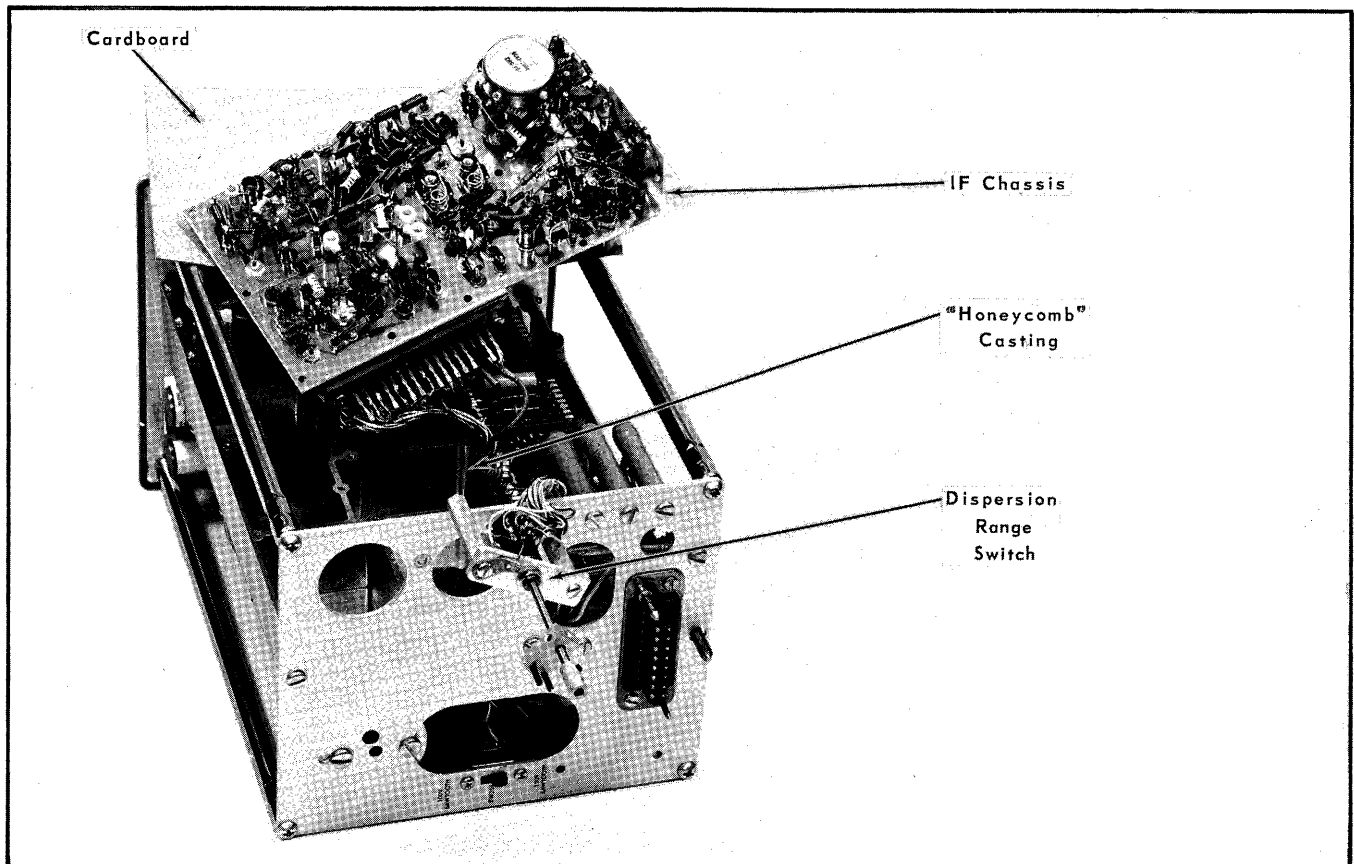

Fig. 4-2. Removing the IF Chassis.

Maintenance—Type 1L20

in Step 4, and the cables. See Fig. 4-3 and Table 4-3 for the correct hook-up.

Table 4-3

PIN	Square Pin Connector WIRING COLOR CODE
A	White—no tracer
B	White—brown tracer (large wire)
C	White—yellow tracer
D	White—green tracer
E	White—black & red tracers
F	White—brown-black traces (+100 V)
G	White—black-brown tracers (+10 V)
H	Tan—brown & green tracers (−150 V)
I	No connection
J	No connection

Remounting the Phase Lock Assembly

1. Remove the three phase-lock control nuts, V620, and the cables (if they were replaced in Step 8 of the procedure given above).

2. Slide the phase-lock chassis back into its cover plate.

3. Replace the six Phillips head screws fastening the phase-lock chassis to the phase-lock cover.

4. Remount the phase-lock assembly on the main chassis. Guide the handle of the INT 1 MHz REF FREQ switch into place with a small screwdriver.

5. Replace the nuts securing the front panel controls and the rear tab.

IMPORTANT

Be sure the correct nut is used to secure the INT 1 MHz REF FREQ switch. Because of the thread difference, use of the wrong nut will cause binding and damage the threads.

6. Reconnect the cabling as shown in Fig. 4-3 and Table 4-3.

7. Replace the FINE FREQ control knob. Be sure it is indexed correctly—see step 7q of the calibration procedure.

Component Replacement

Ceramic Strips. Unsolder all connections, then use a $\frac{3}{8}$ inch diameter by 3 inch long plastic or hardwood dowel and a small (2 to 4 oz.) mallet to knock the stud pins (see Fig. 4-4) out of the chassis. Place one end of the dowel on the end of the stud pin protruding through the chassis. Rap the opposite end of the dowel smartly with the mallet. When both studs of the strip have been loosened in this fashion, the strip is removed as a unit. The spacers will probably come out with

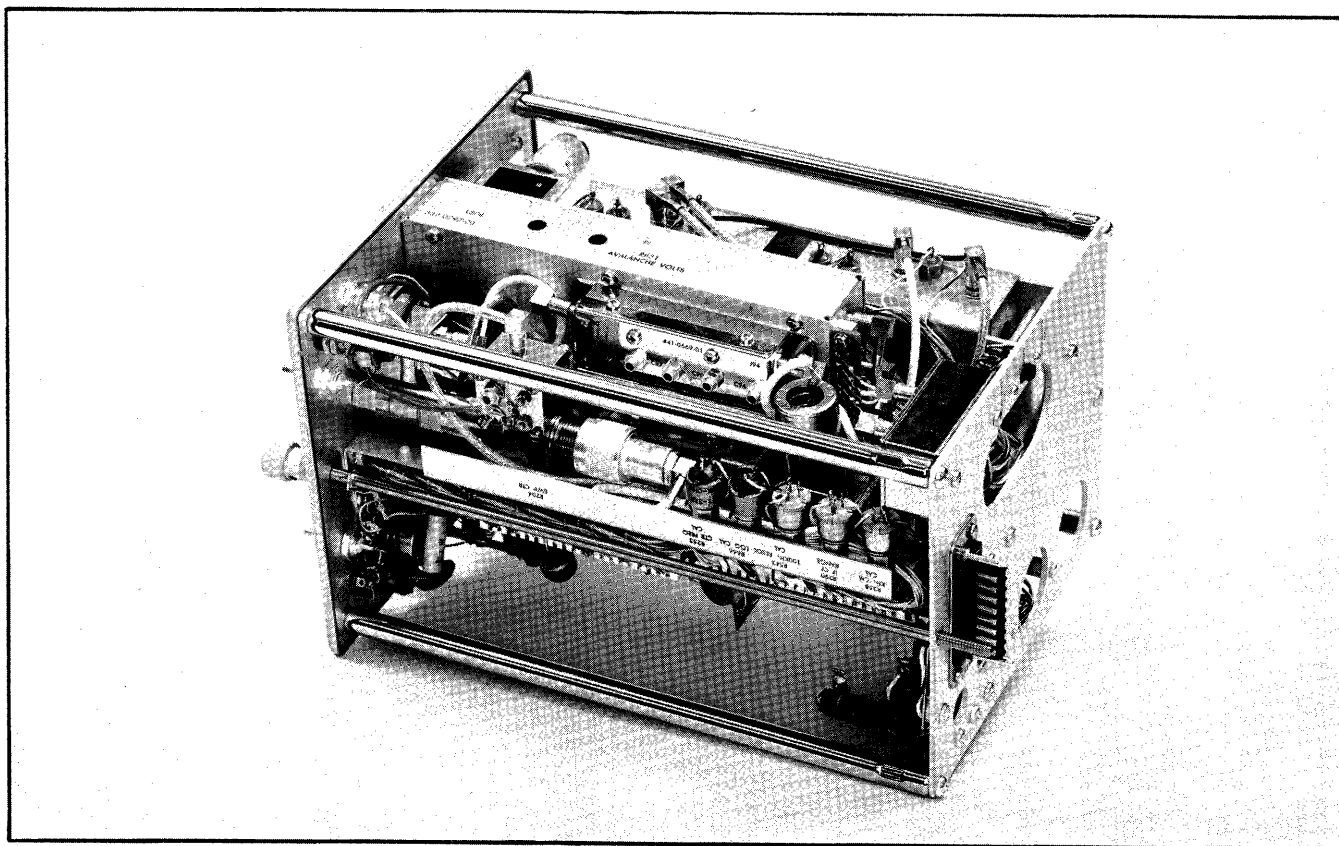

Fig. 4-3. Wiring and cable connections to Phase-Lock assembly.

the studs. If not, they can be pulled out separately. An alternative method of removing the terminal strip is to use diagonal cutters to cut off the sides of the studs. The ceramic strip is removed and the studs pulled from the chassis with a pair of pliers.

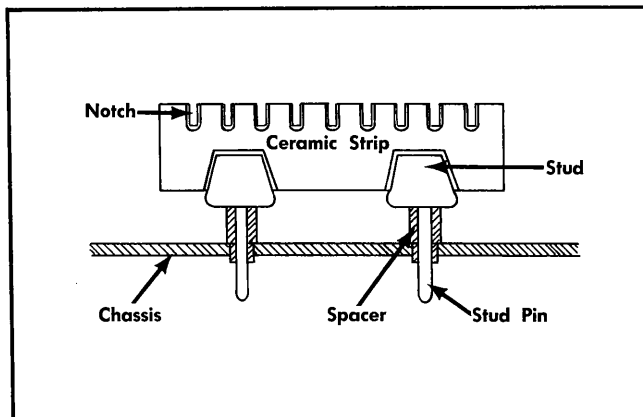

Fig. 4-4. Typical ceramic strip assembly.

After the damaged strip has been removed, place the undamaged spacers in the chassis holes. Then, carefully press the studs into the spacers until completely seated. If necessary, use a soft mallet and tap lightly, directly over the stud area of the strip.

Soldering Techniques

Ceramic Strips. Because of the shape of the ceramic strip terminals, it is recommended that a soldering iron with a wedge-shaped tip be used. A wedge-shaped tip allows the heat to be concentrated on the solder in the terminals. It is important to use as little heat as possible while producing a full-flow joint. A special silver-bearing solder is used to establish a better bond to the plated notches in the ceramic strip. This bond may be broken by repeated use of ordinary tin-lead solder, or by excessive heat. Occasional use of ordinary 60/40 solder will not break the bond, but it is advisable to stock solder containing about 3% silver for the maintenance of Tektronix instruments. This solder may be purchased directly from Tektronix, Inc. in one-pound rolls; order by Part Number 251-0514-00.

The step-by-step technique is as follows:

1. Use long-nose pliers for the heat sink. Attach pliers between the component and the point where heat is applied.
2. Use a 50- to 75-watt soldering iron with a clean tip, properly tinned with solder containing about 3% silver.
3. Apply heat directly to the solder in the terminal notch without touching the ceramic. Do not twist the iron in the notch, as this may chip or break the ceramic strip.
4. Apply only enough heat to make the solder flow freely.
5. Do not attempt to fill the notch with solder; instead, apply only enough solder to cover the wires adequately and form a small fillet. Over-filling the notches may result in cracked terminal strips. If the lead extends beyond the solder joint, clip off the excess close to the joint.

6. Remove all wire clippings from the chassis.

Circuit Board Assemblies. Use ordinary electronic grade rosin core 60/40 solder and a 35- to 40-watt pencil soldering iron with a $\frac{1}{8}$ inch wide chisel tip. The tip of the iron should be clean and properly tinned for best heat transfer in a short time to the soldered connection. A higher wattage soldering iron, if used and applied for too long a time, ruins the bond between the etched wiring and base material by charring the glass epoxy laminate.

The step-by-step technique is as follows:

1. To remove a component, cut the leads near the body. This frees the leads for individual unsoldering.
2. Grip the lead with needle-nose pliers. Apply the tinned tip of the soldering iron to the lead between the pliers and the board then pull gently.
3. When the solder first begins to melt, the lead will come out, leaving a clean hole. If the hole is not clean, use the soldering iron and a toothpick or a piece of enameled wire to open the terminal hole. Do not attempt to drill the solder out, or the "through-hole" plating might be destroyed.
4. Clean the leads on the new component and bend them to the correct shape. Carefully insert the leads into the holes from which the defective component was removed.
5. Apply the iron and a little solder to the connection to finish the solder joint.

Transistor Replacement

Transistors should not be replaced unless they are actually defective. Transistor defects usually take the form of the transistor opening, shorting, or developing excessive leakage. These and other defects can usually be located by signal tracing, by making in-circuit voltage checks, or by using the substitution method.

NOTE

If a transistor is removed from its socket, be sure to replace it in exactly the same position. Some transistors can be placed in the socket in four different positions. Fig. 4-5 shows the correct connections for the different transistor and socket combinations used in the Type 1L20. If a defective transistor is being replaced, the new transistor will probably have straight leads. Be sure to cut and bend the new leads so that they are identical to the leads of the old transistor.

Troubleshooting Techniques

This troubleshooting procedure is arranged in an order which checks the simple trouble possibilities before proceeding with extensive troubleshooting. The first few checks assure proper connection, operation, and calibration. If the trouble is not located by these checks, the remaining steps aid in locating the defective component. When the defective component is located, it should be replaced following the replacement procedures given in this section.

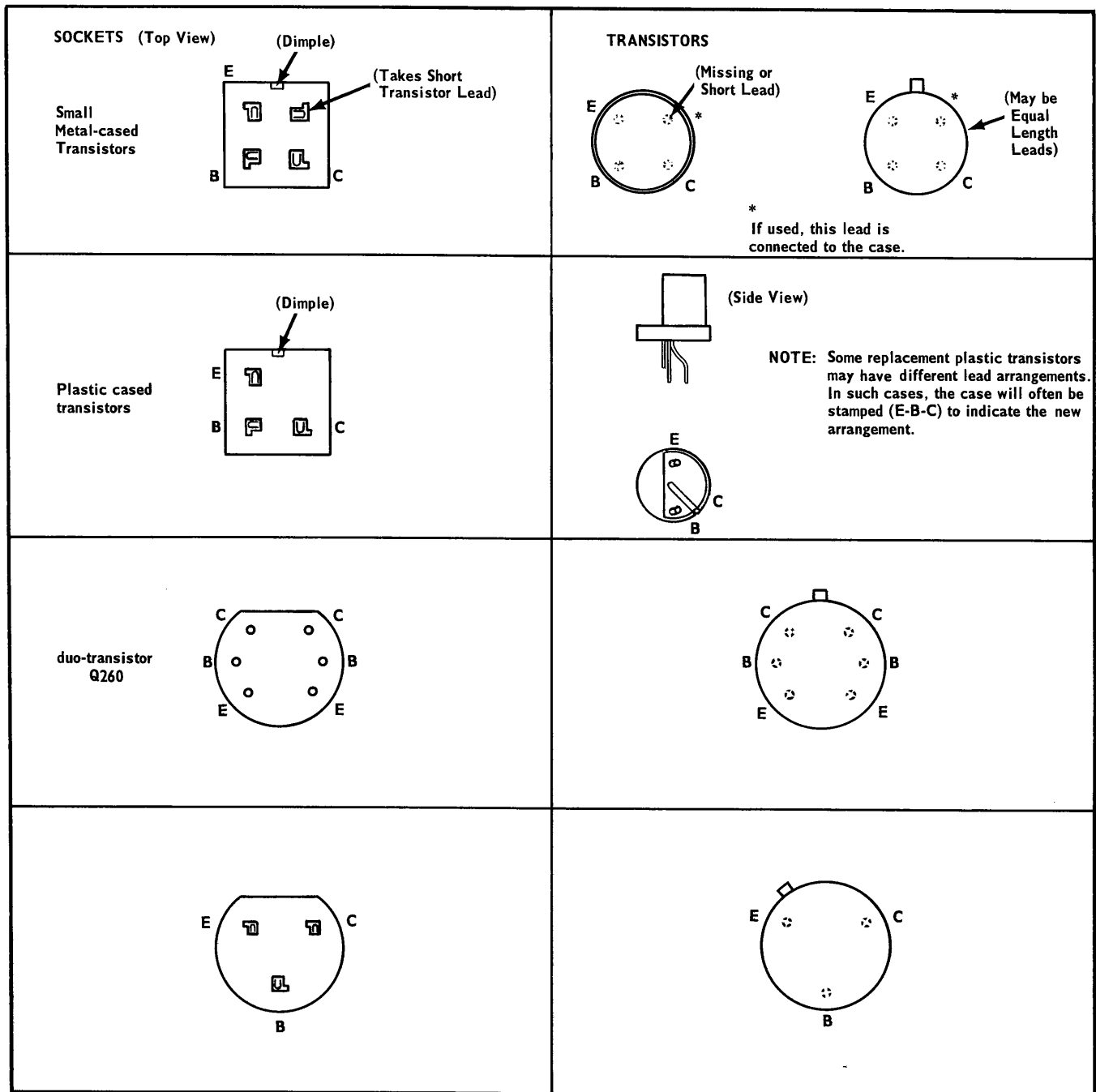

Fig. 4-5. Transistor lead and socket connections as viewed from the top of the chassis.

Check Associated Equipment. Before proceeding with troubleshooting of the Analyzer, check that the equipment used with it is operating correctly. Check that the signal is properly connected and that the interconnecting cables or probe are not defective.

Also, check the oscilloscope to make sure that it is operating properly, and that the sweep sawtooth signal is present at the oscilloscope Sawtooth Out connector and is connected to the SWEEP INPUT connector of the Plug-In Unit. A faulty power supply in the oscilloscope can cause a variety of unusual trouble symptoms. The quickest way to check the operation of the oscilloscope is with another vertical plug-in

unit if one is available. If faulty operation is still noted with a different plug-in unit, the trouble can be assumed to be in the oscilloscope.

Check Control Settings. Incorrect control settings can indicate a trouble that does not exist. For example, if the VERTICAL DISPLAY switch is in the VIDEO position there can be no spectrum display. As another example, if the DISPERSION switch is set to 0, there will be no frequency sweep and probably no vertical deflection unless the RF Frequency controls are moved by hand. If there is any question about the correct function or operation of any control, see the Operating Instructions section of this manual.

Check Instrumentation Calibration. Check the calibration of the instrument, or the affected circuit if the trouble exists in one circuit. The indicated trouble may only be a result of misadjustment or may be corrected by recalibration. Complete instructions are given in the Calibration section of this manual. Individual calibration steps can be performed out of sequence in some cases. However, if the circuit affects the calibration of other circuits in the instrument or if several controls are interacting, a more complete calibration will be necessary. Before you change any settings during this check, note the settings so that you can return the controls to their original positions. This will often make recalibration much easier.

Isolate the Trouble to a Part of the Instrument. Although some troubles may disrupt the operation of the entire instrument, most troubles will affect the operation of ONLY ONE AREA or CIRCUIT.

Visual Check. Visually check the circuit in which the trouble is located. Many troubles can be located by visual indications such as unsoldered connections, broken wires, damaged components, etc.

Check Voltages and Waveforms. Often the defective component can be located by checking for the correct voltages or waveforms in the circuit. Typical voltages and waveforms are given in the Schematic Diagrams.

NOTE

Voltages and waveforms given on the diagrams are not absolute and may vary slightly between instruments. To obtain operating conditions similar to those used to take these readings, see the first page of the schematics.

Most voltage measurements can be taken with a 20,000 ohms/volt DC voltmeter, but do not use a low-volts range on a high impedance circuit. Use a higher range or an oscillo-

scope within $\times 10$ probe. Accuracy of the voltmeter should be within 3% on all ranges. Be sure that the test probes are well insulated to prevent accidental shorting of the components.

For checking waveforms, use a test oscilloscope which has the following minimum specifications:

Bandwidth: DC to 10 MHz.

Deflection Factor: 0.05 Volts/division.

Input Impedance: 10 M Ω paralleled by 10 pF when using a $10\times$ probe.

Connections to the IF Chassis and to the Phase-Lock are made through square-pin connectors and clips. These connectors make convenient test points for troubleshooting, since much of the circuitry connected to them is inaccessible without disassembly of the instrument.

Tables 4-4, 4-5 and 4-6 list the DC resistance between the various pins and ground, first with the cable-clips connected to the pins, and then with all the clips disconnected. The tables also list the resistance between the pins of P11 (the rear-plate connector) and ground.

The color code of the wires soldered to the clips is the same as the color code of the wires soldered to the pins except as noted; if the clips are disconnected, be sure that they are **all** reconnected properly before the power is applied.

The resistance measurements may vary considerably. Because of the semiconductors used in the circuitry, the ohmmeter readings will be affected by the biasing supplied by the internal voltages of the meter. Since ohmmeters differ in the internal voltage used on each range and in the currents required for deflection, the readings can vary as much as 50% between different types of meters, even when using the same range. For future reference, empty columns are provided in each table for logging your own measurements and the type of meter used.

TABLE 4-4
Phase Lock Square-Pin Connectors

Pin	Resistance in Ohms ¹			
	Cable Connected		Cable Disconnected	
		(Reversed Polarity)		(Reversed Polarity)
A	0	0	0	0
B	2.7 k Ω	9.5 k Ω	4.4 k Ω	16 k Ω
C	5.6 k Ω	5.4 k Ω	10 M Ω	10 M Ω
(brown) D	65 k Ω	85 k Ω	∞	∞
(yellow) E	70 k Ω	85 k Ω	∞	∞
F	4.5 k Ω	3.4 k Ω	25 k Ω	6.5 k Ω
G	2 k Ω	1.9 k Ω	∞	∞
H	5.4 k Ω	5.6 k Ω	60 k Ω	150 k Ω
I	NC		NC	
J	NC		NC	

Maintenance—Type 1L20

Check Individual Components. The following procedures describe methods of checking individual components in the Type 1L20.

Transistors. The best check of transistor operation is actual performance under operating conditions. To check transistors using a voltmeter, measure the emitter-to-base and emitter-to-collector voltage and determine if the voltages are consistent with the normal circuit voltages given on the schematic diagrams.

TABLE 4-5

P11 Connector (Mounted on Rear Plate)

Meter _____

Pin	Resistance in Ohms ¹		
			(Reversed Polarity)
1	70 kΩ		84 kΩ
2	0		0
3	5.4 kΩ		5.4 kΩ
4 - 8	NC		
9	5.4 kΩ		5.6 kΩ
10	4.6 kΩ		3.4 kΩ
11	50 kΩ		200 kΩ
12 - 14	NC		
15	2.4 kΩ		2.3 kΩ
16	NC		

NOTE

The shielded chassis of the Type 1L20 make it very difficult to reach much of the socket wiring for waveform and voltage checking. In many cases, it is easier to take these measurements from the top of the chassis by touching the probe to the transistor lead between the transistor body and the socket pin. This is especially true of the black epoxy-cased transistors. (See Fig. 4-5.)

If there is some doubt about whether a transistor is good, substitute a new transistor; but first, be certain a defect in the circuit did not cause the first transistor to fail. Otherwise the new transistor may be damaged as soon as it is subject to the same conditions. If the original transistor is good, return it to the same socket. Unnecessary replacement of transistors is not only expensive but may also result in needless recalibration of the instrument.

If substitute transistors are not available, a dynamic tester such as a Tektronix Type 575 may be used. Static-type testers are not as meaningful since they do not check operation under operating conditions.

Diodes. A diode can be checked for an open or shorted condition by measuring the resistance between terminals. With an ohmmeter scale having an internal source of about 1.5 volts, the resistance should be very high in one direction and very low when the leads are reversed.

CAUTION

Do not use an ohmmeter scale that has a high internal current, and do not use this technique to check tunnel diodes.

TABLE 4-6

IF Chassis Square-Pin Connectors

Meter _____

Resistance in Ohms¹

Pin	Cable Connected		Cable Disconnected	
		Reverse Polarity		Reverse Polarity
A	0		0	
B	1 k		∞	
C	∞		∞	
D	5.6 kΩ		90 kΩ	
E	3 kΩ		4 kΩ	
F	2 kΩ	1.8 kΩ	2.7 kΩ	3.5 kΩ
G	11 kΩ	2.5 kΩ	∞	2.7 kΩ
H	3 kΩ	2.4 kΩ	∞	4.2 kΩ
I	11 kΩ	2.8 kΩ	∞	2.9 kΩ
J	850	850	280 kΩ	2.7 kΩ
K	27 kΩ	6 kΩ	220 kΩ	14 kΩ
L	90 kΩ	3.7 kΩ	∞	4 kΩ
M	5 kΩ	250 kΩ	11 kΩ	∞
N	100 kΩ	2.7 kΩ	∞	2.7 kΩ
O	100 kΩ	2.7 kΩ	∞	2.8 kΩ
P	100 kΩ	6 kΩ	150 kΩ	∞

¹Resistances printed in the tables were measured with a Simpson Electric Co. Model 262 Multimeter.

0 Ω—40 kΩ readings were taken on the R × 1 k range.

50 kΩ—∞ readings were taken on the R × 100 k range.

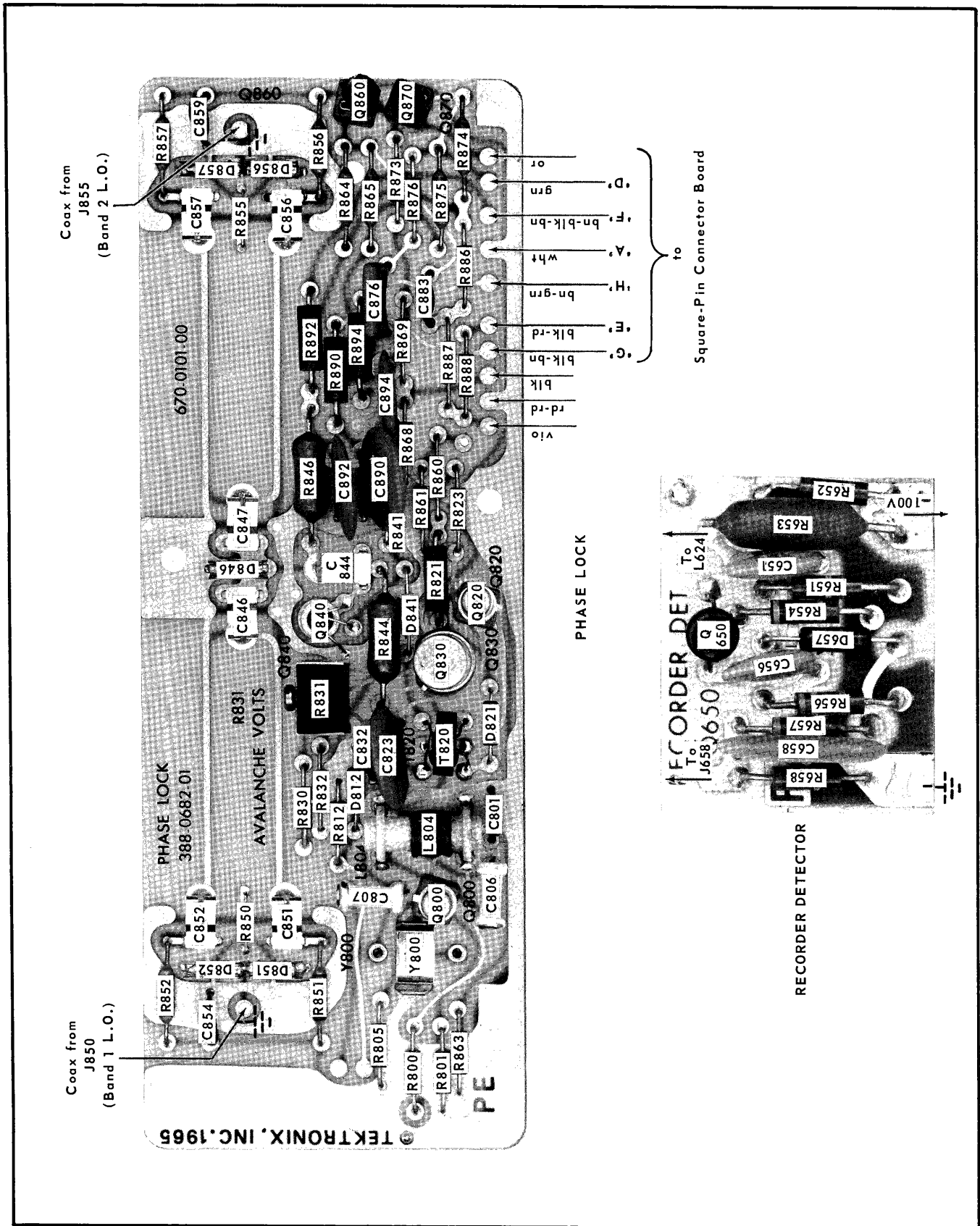

Fig. 4-6. Phase Lock and Recorder Detector Circuit Boards.

SECTION 5

PERFORMANCE CHECK

Introduction

This Performance Check Procedure is offered to provide a systematic method of checking the performance of the Type 1L20 Spectrum Analyzer without changing any of the internal calibration adjustments. The procedure may be used for incoming inspections, calibration verification, reliability testing, etc.

The instrument should be checked following this procedure after each 500 hours of operation, or every six months if it is operated intermittently. Also follow the steps given in the appropriate section of this Performance Check after any corrective maintenance work.

Failure to meet the performance requirements given in this procedure indicates that the instrument requires internal checks and/or adjustments.

RECOMMENDED EQUIPMENT

The following equipment is recommended for a complete performance check. Specifications given are the minimum necessary to check the Analyzer to the accuracy given in the Characteristics section of this manual. If equipment is substituted, it must meet or exceed the specifications of the recommended equipment. Proper settings for any substitute equipment must be determined by the user.

1. Oscilloscope. Any Tektronix oscilloscope which accepts 1- or letter-Series vertical Plug-In Units.
2. Test Oscilloscope with 1X and 10X probes; minimum deflection factor. 0.01 volts/division; frequency response, DC to 10 MHz. Recommended equipment—Any Tektronix oscilloscope meeting the above requirements.
3. Marker Generator, with output frequencies (timing pulses) 1 kHz to 20 MHz (1 mS to .05 μ S); timing accuracy, $\pm 0.0011\%$; 50 MHz, 100 MHz and 200 MHz are very desirable but not absolutely necessary. Recommended equipment—Tektronix Type 184 Time-Mark Generator; or a Tektronix Type 180A Time-Mark Generator and Harmonic Modulator Unit, Tektronix Part No. 067-0518-00.
4. Calibrated Amplitude—Calibrated Frequency RF Generator, with frequency range 10 MHz to 400 MHz variable; frequency accuracy, $\pm 1\%$; output amplitude, -100 dBm to 0 dBm; amplitude accuracy, $\pm 1\%$; and output impedance, 50 Ω . Suggested equipment—Hewlett Packard Type 608D UHF Signal Generator.
5. 10:1 Attenuator, BNC connectors, Tektronix Part No. 011-0059-00.
6. Coaxial Cable, with BNC connectors, 3 needed. Tektronix Part No. 012-0057-00.
7. Connector Adapters, Type BNC female to Type GR, Tektronix Part No. 017-0063-00 (General Radio No. 874-QBJA); Type GR to Type N Male, Tektronix Part No. 017-0021-00 (General Radio No. 874-QNJ).

8. Small Screwdriver, $\frac{3}{32}$ inch blade, Tektronix Part No. 003-0192-00.

9. Flexible Cable Plug-In Extension, Tektronix Part No. 012-0038-00.

10. Calibrated Frequency RF Generators. Needed to check sensitivity and frequency calibration accuracy of Bands 3-5 (500 MHz to 4200 MHz). RF Generator characteristics are: frequency range, 500 MHz to 4200 MHz; frequency accuracy, $\pm 1\%$; signal amplitude, -100 dBm to -30 dBm; amplitude accuracy; ± 1 dB; and output impedance, 50 Ω . Suggested equipment:

- a. Hewlett Packard Type 612 UHF Signal Generator 500 MHz to 850 MHz.
- b. Hewlett Packard Type 8614 UHF Signal Generator 1500 MHz to 2000 MHz.
- c. Hewlett Packard Type 8616 UHF Signal Generator 2500 MHz to 4200 MHz.

11. Sine-Wave Generator(s). Needed to check frequency response of the VIDEO INPUT circuit. Generator characteristics: output range, 10 Hz to 50 kHz and 50 kHz to >10 MHz, and frequency accuracy, $\pm 5\%$.

Suggested equipment: for 10 Hz to 50 kHz, use Heath Co. Model IG-72 Audio Generator. For 50 kHz to >10 MHz, use Tektronix Type 191 Signal Generator.

12. DC Voltmeter. Needed to check + 10 V DC OUT. Sensitivity, $\geq 5000 \Omega/\text{Volt}$; and accuracy, $\pm 1\%$ at 10 volts.

PROCEDURE

NOTE

Several steps in the following procedure call for a 200 MHz signal (or a sub-harmonic of 200 MHz) to be applied to the RF INPUT connector. This signal will feed through the Mixer and appear on the CRT without being tuned in with the RF CENTER FREQ control, since it is already at the center frequency of the first IF. To avoid interfering with this IF feed-through signal, position any tunable signals off the screen with the RF CENTER FREQ control.

In the following procedure, control settings are called out at the start of each major step. If a control is not called out, it can be assumed that it does not need to be preset at that time.

1. Preliminary set-up of equipment:

- a. Before inserting the Spectrum Analyzer into the oscilloscope, check Table 2-2 or the oscilloscope instruction manual to determine the amplitude of the sawtooth output voltage and set SW201 (slide switch mounted on the rear plate of the Analyzer) to the appropriate position.

Performance Check—Type 1L20

b. Insert the Spectrum Analyzer into the oscilloscope, fasten the securing latch, and turn on the power. Allow 10-20 minutes for warm-up.

c. Connect the oscilloscope Sawtooth Out (or Sawtooth A) connector to the Analyzer SWEEP INPUT connector.

CAUTION

Be careful when making this connection, since the sawtooth voltage can give a painful shock. Also be sure to plug the cable into the SWEEP INPUT, not one of the nearby RF INPUT connectors.

d. Set the oscilloscope Mode (or Horizontal Display) switch to A or Normal.

e. Set the sweep controls for a free-running 5 ms/cm sweep.

2. Set Front Panel IF CENTER FREQ CAL Adjustment

a. Preset the controls of the Spectrum Analyzer as follows:

POS	Position the trace on the bottom line of the graticule
IF ATTEN	ALL OFF
IF CENTER FREQ	Midrange (000)
FINE IF CENTER FREQ	Midrange
DISPERSION RANGE	MHz/CM
DISPERSION—COUPLED RESOLUTION	10
VIDEO FILTER	Off (down)
VERTICAL DISPLAY	LIN
RF INPUTS (Switch)	BAND 1

b. Apply a 100 MHz signal from the Type 184 Time-Mark Generator (or a 50 MHz signal if using the Type 180A) to the Band 1 RF INPUT connector through a 10:1 50 Ω attenuator.

c. Adjust the GAIN control so that the CRT display shows a signal pip about 4 divisions in amplitude.

d. Set the IF CENTER FREQ CAL adjustment so that the signal pip does not shift as the DISPERSION—COUPLED RESOLUTION control is rotated between 10 and .2 (outer ring).

e. Set the oscilloscope Horizontal Position controls to align the pip with the center line of the graticule.

f. Set the DISPERSION—COUPLED RESOLUTION control to 1 (outer ring). The horizontal shift of the pip should not be more than 1 centimeter when the DISPERSION RANGE control is changed to the kHz/cm position.

3. Set Front-Panel DISP CAL Adjustment

a. Preset the controls of the Spectrum Analyzer as follows:

POS	Position the trace to the bottom line of the graticule.
-----	---

IF ATTEN	ALL OFF
IF CENTER FREQ	Midrange (000)
FINE IF CENTER FREQ	Midrange
DISPERSION RANGE	MHz/CM
DISPERSION—COUPLED RESOLUTION	10 (outer ring)
VIDEO FILTER	Off (down)
VERTICAL DISPLAY	SQ LAW
RF INPUTS (Switch)	BAND 1
PHASE LOCK	INT 1 MHz REF FREQ

b. Apply 10 ns and 0.1 μ s markers (100 MHz and 10 MHz) from the Time Mark Generator to the RF INPUT connector through a 50 Ω 10:1 attenuator.

c. Adjust the GAIN control for a marker display about 4 divisions high.

d. Adjust the FINE IF CENTER FREQ control to keep the markers aligned with the graticule lines while setting the DISP CAL adjustment from one marker per centimeter from the first to the ninth graticule lines. Ignore the right and left edges of the graticule—see Fig. 5-1.

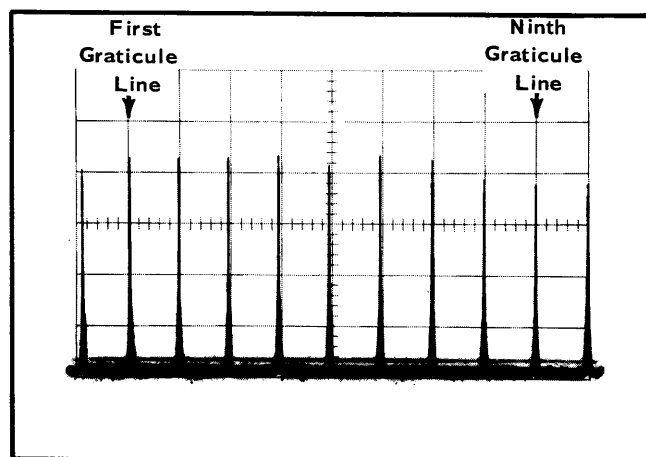

Fig. 5-1. Typical display for DISP CAL adjustment (Step 3).

4. 1 MHz CAL MARKERS Signal Check

a. Apply 10 ns (100 MHz) and 1 μ s (1 MHz) markers from the Time Mark Generator to the RF INPUT connector through a 10:1 Attenuator.

b. Change DISPERSION to 1 MHz/CM and align the first marker with the first graticule line as was done in Step 3d above.

c. Note the horizontal position of the ninth marker.

d. Disconnect the generator and connect the 1 MHz CAL MARKER OUT signal in its place.

e. Align the first marker with the first graticule line. The ninth marker should be in the position noted in step c above.

5. Phase Lock Check and RF CENTER FREQ Dial Calibration Check

a. Preset the controls of the Spectrum Analyzer as follows:

POS Position the trace to the bottom line of the graticule.

IF ATTEN ALL OFF

IF CENTER FREQ Midrange (000)

FINE IF CENTER FREQ Midrange

DISPERSION RANGE MHz/CM

DISPERSION— 1

COUPLED RESOLUTION

VERTICAL DISPLAY LIN

PHASE LOCK INT 1 MHz REF FREQ

b. Check the Band 1 frequency calibration every 10 MHz by applying the appropriate -70 dBm signals from the UHF Signal Generator to the BAND 1 RF INPUT connector. Maximum error is ± 2 MHz $\pm 1\%$ of the dial reading for this step and steps c, d, and e following.

At the same time, check for phase-lock zero beats about every 1 MHz by depressing the LOCK CHECK pushbutton while the RF CENTER FREQ setting is being changed. Check for a phase-locked display at 10 MHz, 100 MHz, and 270 MHz.

c. Move the generator output to the BANDS 2-5 RF INPUT connector and check the dial accuracy at 275 MHz, 375 MHz, and 475 MHz. Check the phase lock zero beats as before, and check for a phase-locked display at 275 MHz and 500 MHz.

d. Check the dial accuracy at 500 MHz, 700 MHz, and 900 MHz (using the second harmonic of the signal generator for 900 MHz). Check for zero beats as before and check for a phase-locked display at 900 MHz.

e. Since Bands 3, 4, and 5 use harmonics of the Band 2 Local Oscillator output, it follows that if the accuracy of Band 2 is within specifications, then Bands 3, 4 and 5 will also be within the specifications.

6. Sensitivity and Frequency Range Checks

a. Preset the controls of the Spectrum Analyzer as follows:

POS Position the trace to the bottom line of the graticule.

IF ATTEN ALL OFF

DISPERSION RANGE kHz/CM

DISPERSION— 5 (inner ring)

COUPLED RESOLUTION

VIDEO FILTER Off (down)

VERTICAL DISPLAY LIN

RF INPUT BAND 1

RF CENTER FREQ 10

FINE FREQ Fully Clockwise

b. Apply a -30 dBm 10 MHz signal from the UHF Signal Generator to the BAND 1 RF INPUT connector.

c. Center the signal on the graticule with the Frequency control of the Signal Generator.

d. Adjust the Analyzer GAIN control until the average noise level is one division in amplitude.

e. Adjust the RF Attenuator control of the generator so that the displayed signal is twice as high as the noise level. (See Fig. 5-2).

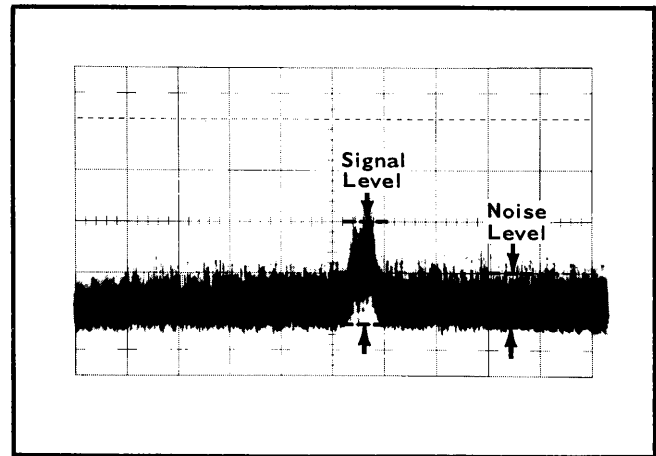

Fig. 5-2. Typical display for Sensitivity check (Step 6).

f. Check the setting of the RF Atten dial of the generator. The signal strength should be -90 dBm or less.

g. Check the sensitivity over the rest of the frequency range of the Analyzer as directed in Table 5-1. On bands 2-5, readjust the Analyzer MIXER PEAKING control for maximum signal amplitude whenever the frequency is changed.

TABLE 5-1

Suggested Signal Generator (Refer to recommended equipment list)	Frequency in MHz	Band	Sensitivity (2:1 Signal/Noise)
Type 608D	10	1	-80 dBm
	140		
	275		
	275		
Type 612	400	2	-90 dBm
	900		
Type 8614	850	3	-80 dBm
	1500		
	2000		
Type 8616	1950	4	-75 dBm
	2500		
	3100		
	3000		
	3500		
	4200	5	-70 dBm

h. When the 100 kHz RESOLUTION display is within the sensitivity requirements given in Table 5-1, the 1 kHz RESOLUTION display will also be within its sensitivity requirements.

7. Resolution Check

a. Preset the controls of the Spectrum Analyzer as follows:

Performance Check—Type 1L20

POS	Position the trace to the bottom line of the graticule
IF ATTEN	ALL OFF
DISPERSION RANGE	kHz/CM
DISPERSION	50
RESOLUTION	Fully clockwise
VIDEO FILTER	Off (Down)
VERTICAL DISPLAY	LIN
RF INPUT	BANDS 2-5

b. Set the oscilloscope sweep rate to 50 ms/cm.

c. Apply a 200 MHz signal from the Time-Mark Generator HF SELECTOR OUTPUT connector to the BANDS 2-5 RF INPUT connector.

d. Adjust the Analyzer GAIN control for a 6 centimeter signal.

e. Check the display for a signal width of 2 centimeters at 3 centimeters above the base line. (See Fig. 5-3.)

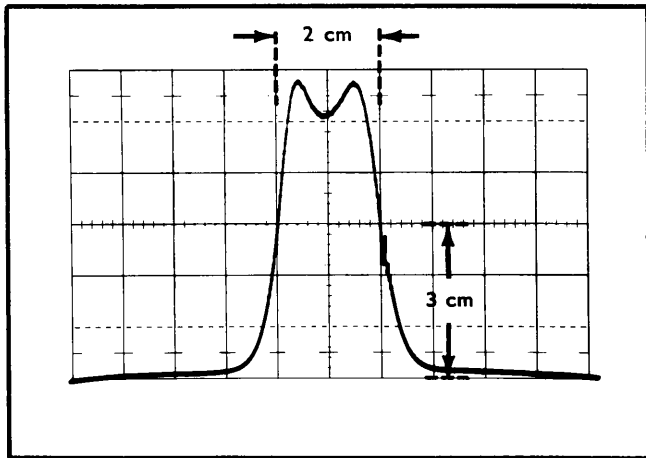

Fig. 5-3. Typical for Resolution Check (Step 7).

8. IF Attenuator Accuracy Check

a. Preset the controls of the Spectrum Analyzer as follows:

DISPERSION RANGE	MHz/CM
DISPERSION—	1
COUPLED RESOLUTION	
VIDEO FILTER	Off (Down)
VERTICAL DISPLAY	LIN
RF INPUT	BAND 1
IF ATTEN	All OFF

b. Apply a -70 dBm 200 MHz signal from the Type 608D RF generator to the BAND 1 RF INPUT connector of the Spectrum Analyzer.

c. Set the Spectrum Analyzer GAIN control so that the 200 MHz signal is exactly 6 centimeters high.

d. Switch the 1 dB IF ATTEN switch on (up) and adjust the Attenuator control of the generator so that the 200 MHz

display is exactly 6 centimeters high. The generator Attenuator control should read -69 dBm ± 0.1 dBm.

e. Switch the 1 dB IF ATTEN switch to OFF.

f. Check the rest of the IF ATTEN steps as directed in Table 5-2.

TABLE 5-2

Spectrum Analyzer IF ATTEN switch On	RF Generator Attenuator Control Setting
2 dB	-68 dBm $\pm .2$ dBm
4 dB	-66 dBm $\pm .4$ dBm
8 dB	-62 dBm $\pm .8$ dBm
16 dB	-54 dBm ± 1.6 dBm
20 dB	-50 dBm ± 2.0 dBm

9. IF CENTER FREQ Control Range Check

a. Preset the controls on the Spectrum Analyzer as follows:

POS	Position the trace to the bottom line of the graticule
IF CENTER FREQ	Midrange (000)
FINE IF CENTER FREQ	Midrange
DISPERSION RANGE	MHz/CM
DISPERSION—	10
COUPLED RESOLUTION	
VERTICAL DISPLAY	LOG
RF INPUT	BANDS 2-5

b. Apply 100 MHz and 10 MHz markers from the Time-Mark Generator to the BANDS 2-5 RF INPUT connector.

c. Adjust the GAIN control so that the 10 MHz markers are visible.

d. The second harmonic of the 100 MHz signal should be centered on the graticule; if it is off-center, readjust the front panel IF CENTER FREQ CAL adjustment.

e. Rotate the 10-turn IF CENTER FREQ control to both ends of its range. The markers must move at least 1 centimeter (10 MHz) from center in each direction.

f. Change the DISPERSION to 5 MHz/CM.

g. Rotate the 10-turn IF CENTER FREQ control through its range. The markers must move at least 25 MHz from center in each direction.

h. Center the 10-turn control and rotate the FINE IF CENTER FREQ control to the ends of its rotation. The markers must move at least 1 MHz in each direction.

i. Change the DISPERSION to 500 kHz/CM.

j. Rotate the 10-turn IF CENTER FREQ control to the ends of its rotation. The markers must move at least 2.5 MHz from center in each direction.

k. Center the 10-turn control and rotate the FINE IF CENTER FREQ control to both ends of its rotation. The markers must move at least 50 kHz in each direction.

10. Display Flatness Check

a. Preset the Spectrum Analyzer controls as follows:

POS	Position the trace to the bottom line of the graticule
IF CENTER FREQ	Midrange (000)
IF ATTEN	All OFF
DISPERSION RANGE	MHz/CM
DISPERSION—	5
COUPLED RESOLUTION	
VIDEO FILTER	Off (down)
VERTICAL DISPLAY	LIN
RF INPUT	BAND 1
RF CENTER FREQ	250 MHz

b. Apply a -50 dBm 250 MHz signal from the UHF Signal Generator to the BAND 1 RF INPUT connector.

c. Set the Analyzer GAIN control for a 5 centimeter signal display.

d. Turn the RF CENTER FREQ control from 225 MHz to 275 MHz and set at the frequency giving the highest amplitude signal.

e. Set the Analyzer GAIN control for a 6 centimeter signal display.

f. Set the 1 dB and 2 dB IF ATTEN switches to On and note the display size. Return the IF ATTEN switch to OFF.

g. Tune the RF CENTER FREQ from 225 MHz to 275 MHz and check that the signal display does not drop below the size noted in step f.

h. Apply a -50 dBm 350 MHz signal from the signal generator to the BANDS 2-5 RF INPUT connector and change the RF INPUTS switch to BANDS 2-5.

i. Set the RF CENTER FREQ dial to 350 MHz.

j. Set the MIXER PEAKING CONTROL for maximum signal amplitude.

k. Set the Analyzer GAIN control for a 5 centimeter display.

l. Turn the RF CENTER FREQ control from 300 MHz to 400 MHz and set at the frequency giving the highest amplitude signal.

m. Set the Analyzer GAIN control for a 6 centimeter signal display.

n. Set the 1 dB and 2 dB IF ATTEN switches to On and note the display size. Return the IF ATTEN switch to OFF.

o. Tune the RF CENTER FREQ from 300 MHz to 400 MHz and check that the signal display does not drop below the display size noted in step n.

11. Dispersion Accuracy Check

a. Preset the controls of the Spectrum Analyzer as follows:

POS	Position the trace to the bottom line of the graticule
-----	--

IF CENTER FREQ	Midrange (000)
DISPERSION RANGE	MHz/CM
DISPERSION—	10
COUPLED RESOLUTION	
VIDEO FILTER	Off (Down)
VERTICAL DISPLAY	LOG
RF INPUT	BANDS 2-5

b. Connect the Marker Output connector of the Type 184 Time-Mark Generator to the BANDS 2-5 RF INPUT connector of the Analyzer through a 10:1 $50\ \Omega$ Attenuator. (To use a Type 180A, see step d below.)

c. Depress the Marker Selector switches for 10 ns (100 MHz) and the modulation signal indicated in Table 5-4. (Be sure the 10 ns switch stays depressed each time the modulation signal is changed.)

d. If a Type 180A Time-Mark Generator is to be used in place of the Type 184, change the procedure of steps b and c as follows.

1. Connect the Marker Out connector of the Type 180A to the RF connector of the Harmonic Modulator Unit and depress the 50 MC switch.

2. Connect a cable between the desired Modulation signal banana jack and the Harmonic Modulator Modu 2 connector.

3. Connect the Harmonic Modulator Modu Harm Out connector to the Analyzer BANDS 2-5 RF INPUT connector.

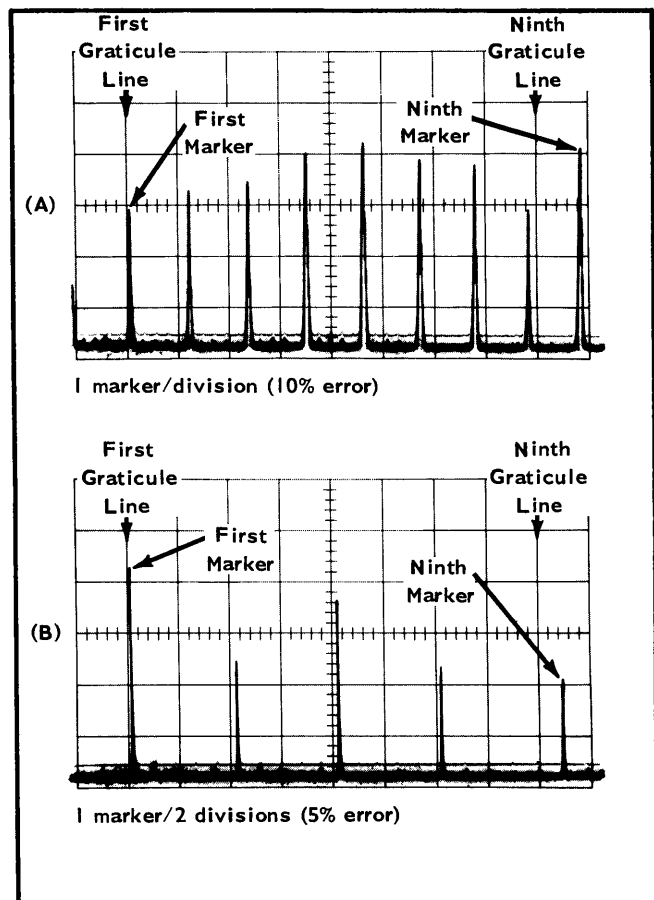

Fig. 5-4. Dispersion Accuracy displays.

TABLE 5-3

DISPERSION/CM	Modulation Signal	CRT Display in Divisions/Marker	Maximum Error	Notes
10 MHz	.1 μ S (10 MHz)	1	\pm 3%	At IF CENTER FREQ control center
5 MHz	.1 μ S (10 MHz)	2	\pm 3%	
2 MHz	.5 μ S (2 MHz)	1	\pm 5%	Over range of IF CENTER FREQ control (\pm 25 MHz)
1 MHz	1 μ S (1 MHz)	1	\pm 7%	
.5 MHz	1 μ S (1 MHz)	2	\pm 10%	
.2 MHz	5 μ S (200 kHz)	1	\pm 15%	
500 kHz	1 μ S (1 MHz)	2	\pm 3%	
200 kHz	5 μ S (200 kHz)	1		
100 kHz	10 μ S (100 kHz)	1		
50 kHz	10 μ S (100 kHz)	2		
20 kHz	50 μ S (20 kHz)	1		
10 kHz	.1 mS (10 kHz)	1		
5 kHz	.1 mS (10 kHz)	2		
2 kHz	.5 mS (2 kHz)	1		
1 kHz	1 mS (1 kHz)	1		

4. Set the Modulator's controls as follows: Modu Freq 2 to On, 60 MC Trap to Out, and the two Variable controls to the settings giving the most readable display.
- e. Adjust the Analyzer's GAIN control for a display about 5 centimeters high.
- f. Use Table 5-3 to check the dispersion accuracy at each DISPERSION/CM setting. Position a modulation pip at the first graticule line and check the ninth pip displacement from the ninth graticule line for displays having 1 division/marker; if the display has 2 divisions/marker, check the fifth marker displacement from the ninth line (see Fig. 5-4).
- g. If the dispersion accuracy is out of tolerance, the instrument should be recalibrated as directed in Section 6.

- b. Set the IF CENTER FREQ controls to midrange.
- c. At each DISPERSION/CM setting of Table 5-3, readjust the DISP CAL adjustment to align the correct markers with the first and ninth graticule lines (see Fig. 5-5). (The IF CENTER FREQ controls may be moved slightly away from center to position a marker at the first graticule line.)
- d. All markers between the first and ninth graticule lines should be within 2.4 millimeters of the appropriate graticule lines.

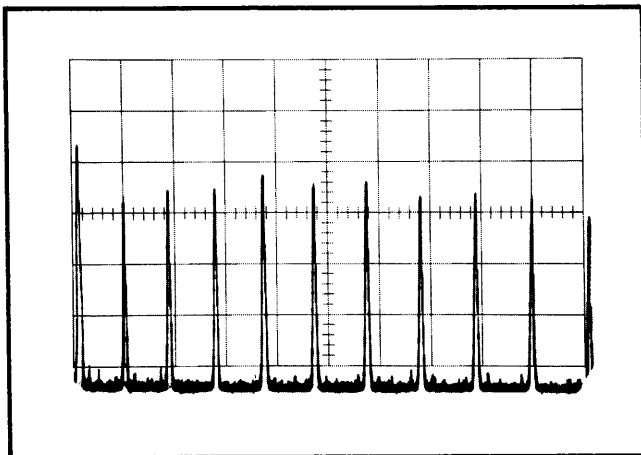

Fig. 5-5. Display for Dispersion Linearity check (Step 12).

12. Dispersion Linearity Check

- a. Set up the equipment as directed in Steps 11a through 11f (above).

13. Dynamic Range Check

- a. Preset the controls of the Spectrum Analyzer as follows:

POS	Position the trace to the bottom of the graticule
IF ATTEN	ALL OFF
IF CENTER FREQ	Midrange
DISPERSION RANGE	MHZ/CM
DISPERSION—COUPLED RESOLUTION	1
VIDEO FILTER	Off (Down)
VERTICAL DISPLAY	LOG
RF INPUT	BANDS 2-5
- b. Apply a -40 dBm 200 MHz signal from the UHF Signal Generator to the BANDS 2-5 RF INPUT connector.
- c. Adjust the GAIN control of the Analyzer for 6 centimeters of signal deflection.
- d. Add 40 dB of IF ATTEN. (Set the 20 dB, 16 dB, and 4 dB switches to On.)
- e. Check that the signal is just discernible.
- f. Set the VERTICAL DISPLAY switch to LIN and switch all the IF ATTEN switches back to OFF.

- g. Adjust the GAIN control of the Analyzer for 6 centimeters of signal deflection.
- h. Add 26 dB of IF ATTEN. (Set the 20 dB, 4 dB, and 2 dB switches to On.)
- i. Check that the signal is just discernible.
- j. Set the VERTICAL DISPLAY switch to SQ LAW and return all IF ATTEN switches to OFF.
- k. Adjust the GAIN control of the Analyzer for 6 centimeters of display.
- l. Add 13 dB of IF ATTEN. (Set the 8 dB, 4 dB, and 1 dB switches to On.)
- m. Check that the signal is just discernible.

14. TO RECORDER Output Check

- a. Preset the controls of the Spectrum Analyzer as follows:

POS	Position the trace to the bottom line of the graticule.
DISPERSION RANGE	MHz/CM
DISPERSION—COUPLED RESOLUTION	1
VIDEO FILTER	Off (Down)
VERTICAL DISPLAY	LIN
INT 1 MHz REF FREQ	Up

- b. Connect the 1 MHz CAL MARKERS OUT to the RF INPUT connector.
- c. Adjust the GAIN control for a 6 centimeter display. (Readjust the POS control if necessary to position the trace to the bottom line of the graticule.)
- d. Measure the TO RECORDER signal with the test oscilloscope. Check for 12 millivolts to 20 millivolts.
- e. Disconnect the test oscilloscope.

15. VIDEO FILTER Check

- a. Set up the Analyzer as directed in Step 5-14a, b, c above.
- b. Switch on the VIDEO FILTER and check for an attenuated display resembling a sawtooth.
- c. Change the sweep rate to 1 sec/cm. The display should be the same in either position of the VIDEO FILTER switch.

16. VIDEO INPUT Frequency Response Check

- a. Insert the Analyzer directly into the oscilloscope plug-in compartment. (Do not use the extension.)
- b. Preset the controls of the Spectrum Analyzer as follows:

POS	Position the trace to the center line of the graticule.
-----	---

GAIN	Full clockwise
VERTICAL DISPLAY	VIDEO

- c. Apply a 50 kHz signal from an audio generator to the VIDEO INPUT connector of the Analyzer. Adjust the Output control of the generator to obtain 4 centimeters of deflection.
- d. Monitor the signal amplitude with a DC coupled test oscilloscope for constant amplitude, and decrease the output frequency of the generator.
- e. Check the frequency at which the Analyzer display falls to 2.8 centimeters. This frequency should be ≤ 16 Hz.
- f. Apply a 50 kHz signal from the Constant Amplitude RF Generator to the VIDEO INPUT connector of the Analyzer. Adjust the signal amplitude for 4 centimeters of deflection.
- g. Increase the signal frequency until the amplitude of the Analyzer display falls to 2.8 centimeters. At this point the output frequency should be ≥ 10 MHz.

17. Incidental Frequency Modulation Check

- a. Insert the Analyzer directly into the oscilloscope plug-in compartment. (Do not use the extension.)
- b. Preset the Spectrum Analyzer controls as follows:

DISPERSION RANGE	kHz/CM
DISPERSION	500
IF ATTEN	All OFF
- c. Apply a 200 MHz signal from the Time-Mark Generator to the BAND 1 RF INPUT connector and center the IF feed through signal on the CRT.
- d. Change the DISPERSION—COUPLED RESOLUTION switch to 1, adjusting the IF CENTER FREQ controls to keep the signal centered on the screen.
- e. Adjust the GAIN control for six centimeters of deflection.
- f. Adjust the POS control for a display similar to Fig. 5-6.

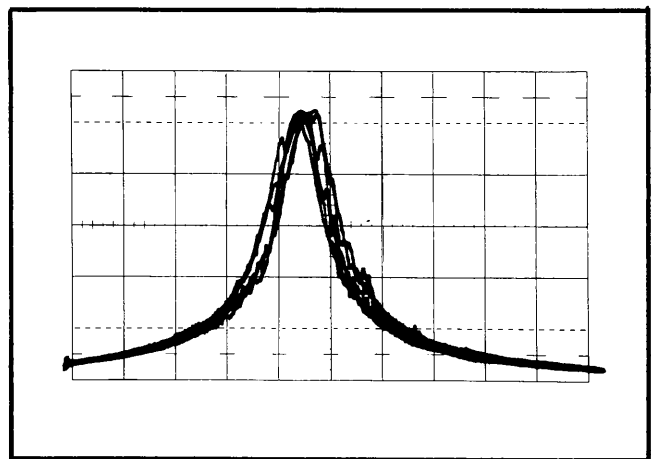

Fig. 5-6. Typical display for Incidental Frequency-Modulation Check (Step 17).

Performance Check—Type 1L20

g. Set the oscilloscope sweep rate to 20 ms/cm. The display must not show more than 1 minor division of frequency modulation.

h. Move the IF feedthrough signal off the screen with the IF CENTER FREQ control and center the tunable signal on the CRT with the RF CENTER FREQ control.

i. Turn the INT 1 MHz REF FREQ to OFF. The display must not show more than 0.8 centimeters of frequency modulation.

j. Turn the INT 1 MHz REF FREQ to On (up) and phase lock the display. (See page 2-5.) The display must not show more than 0.3 centimeters of modulation.

SECTION 6

CALIBRATION

Introduction

This Spectrum Analyzer is a stable laboratory instrument which should not require frequent recalibration. However, its performance should be rechecked as directed in Section 5 after every 500 hours of operation or every six months if used intermittently. This will assure that it is operating properly and indicate the sections of the instrument needing recalibration.

The following procedure is arranged in a sequence which will allow the unit to be checked and calibrated at the same time with the least inter-action of adjustments and reconnection of equipment. If desired, a single step can usually be performed individually, provided interaction between adjustments is considered.

NOTE

If the dial error on Band 1 or Band 2 exceeds ± 2 MHz $\pm 1\%$ of the dial reading, the instrument should be returned to the factory for repair and/or calibration. Local Oscillator and dial tape calibration procedures have been included at the end of this section, but should be used only if the instrument cannot be returned to the factory. Because of the interaction between the adjustments, it will usually be more satisfactory (and more economical) to have the Local Oscillator recalibrated by our factory technicians.

Recommended Equipment

The following equipment is recommended for a complete calibration. Specifications given are the minimum necessary to check and calibrate the Analyzer to the accuracy given in the Characteristics Section of this manual. If equipment is substituted, it must meet or exceed the specifications of the recommended equipment. Proper settings for any substitute equipment must be determined by the user.

1. Oscilloscope. Any Tektronix oscilloscope which accepts 1- or Letter-Series Vertical Plug-In Units.
2. Test Oscilloscope with 1X and 10X probes; minimum sensitivity 0.01 V/div; frequency response DC to 10 MHz. Recommended equipment—Any Tektronix oscilloscope meeting the above requirements.
3. Marker Generator with output frequencies of 1 kHz to 20 MHz, (50 MHz, 100 MHz and 200 MHz are very desirable but not absolutely necessary); timing accuracy, $\pm 0.001\%$. Recommended equipment—Tektronix Type 184 Time-Mark Generator; or a Tektronix Type 180A Time-Mark Generator and a Harmonic Modulator Unit, Tektronix Part No. 067-0518-00.
4. Calibrated Amplitude—Calibrated Frequency RF Generators, with frequency range 10 MHz to 4200 MHz; frequency accuracy $\pm 1\%$; signal amplitude -100 dBm to -30 dBm; amplitude accuracy ± 1 dB; and output impedance 50 Ω . Suggested equipment—Hewlett-Packard UHF signal generators; 10 MHz to 400 MHz, Type 608D; 500 MHz to 850 MHz, Type 612; 1500 MHz to 2000 MHz, Type 8614, and 2500 to 4200 MHz, Type 8616.

5. Sine-Wave Generators (needed to check frequency response of the VIDEO INPUT circuit) with output frequency ranges 10 Hz to 50 kHz and 50 kHz to > 10 MHz; frequency accuracy $\pm 5\%$. Suggested equipment—for 10 Hz to 50 kHz, use Heath Co. Model IG-72 Audio Generator; for 50 kHz to 10 MHz, use Tektronix Type 191 Signal Generator.

6. Swept-Frequency Generator with frequency range 130 MHz to 280 MHz, and amplitude variation, < 0.25 dB. Suggested equipment—Kay Type 122C Sweep Generator.

7. DC Voltmeter, with voltage range 0-10 V; sensitivity 5000 Ω /V, and accuracy $\pm 1\%$.

8. Coaxial Cables, BNC connectors 3 ea Tektronix Part No. 012-0057-00

9. 10:1 Attenuator, BNC connectors Tektronix Part No. 011-0059-00

10. T Connector Tektronix Part No. 103-0030-00

11. Connector Adapters \checkmark
Type BNC Female to Type GR Tektronix Part No. 017-0063-00
(General Radio No. 874-QBJA)

Type GR to Type N Male Tektronix Part No. 017-0021-00
(General Radio No. 874-QNJA)

12. Screwdriver with $\frac{3}{32}$ inch diameter blade Tektronix Part No. 003-0192-00

13. Tuning tool—for $\frac{5}{64}$ inch inside diameter hex slugs (needed to adjust L804 in Step 7c)

Handle Tektronix Part No. 003-0307-00

Insert Tektronix Part No. 003-0310-00

14. Miniature phone plug.

15. Flexible Cable Plug-In Extension Tektronix Part No. 012-0038-00

16. If the SWEEP INPUT patch cord and adapter supplied with the Analyzer are not available, a substitute can be made from a BNC patch cord (Tektronix Part No. 012-0087-00) with a $\frac{1}{2}$ inch length of No. 16 wire inserted in one end. A banana plug patch cord (Tektronix Part No. 012-0031-00) and a BNC to binding post adapter (Tektronix Part No. 103-0033-00) may also be used.

CALIBRATION RECORD AND INDEX

This abridged Calibration Procedure has been provided as an index for locating a specific part of the complete procedure. A brief explanation below each step is included so an experienced calibrator can use the list as a condensed guide. Boxes are provided so each step can be checked off as it is completed. If desired, a check-off copy can be made prior to calibrating the unit. When completed, it can be used as a record of the calibration.

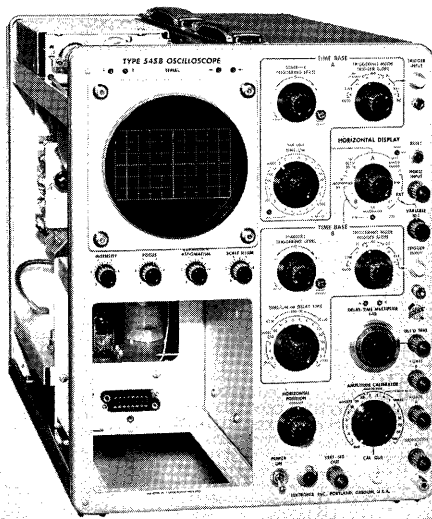

(1)

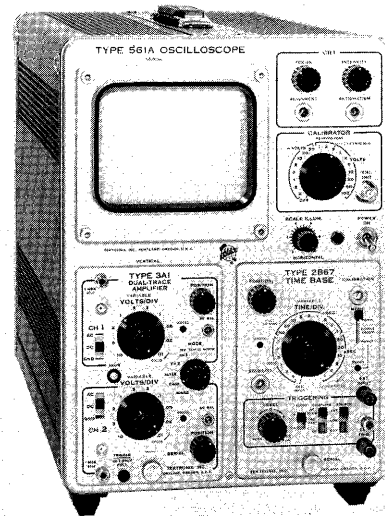

(2)

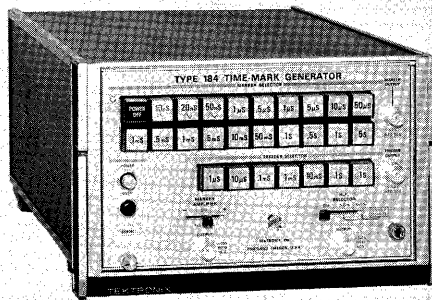

(3)



(4A)

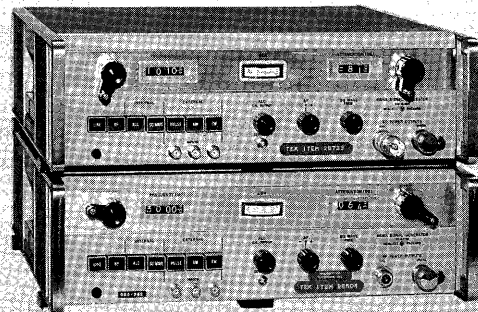

(4B) (4C)

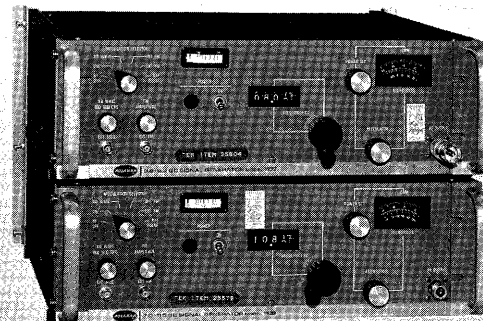

(4D) (4E)

Fig. 6-1. Recommended equipment for calibrating the Type 1L20.

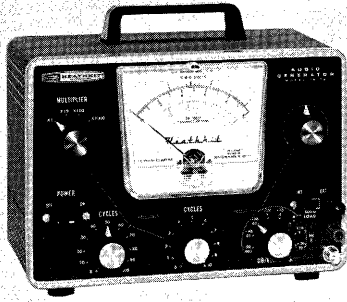

(5)

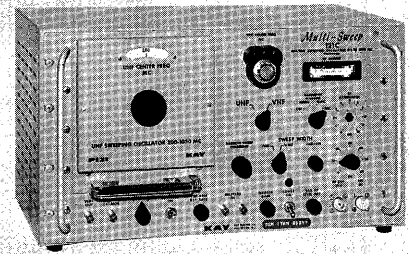
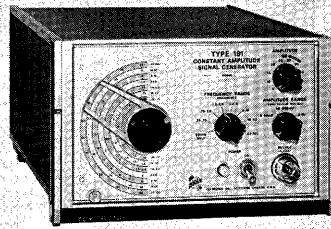

(6)

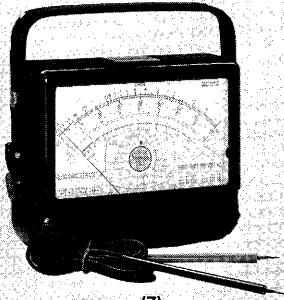

(7)

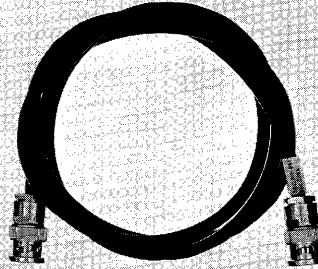

(8)



(9)



(10)



(11)



(12)



(13)



(14)

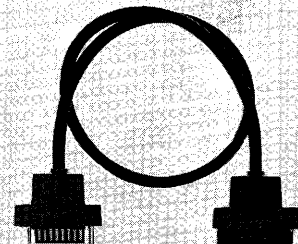

(15)

Fig. 6-2. Recommended Calibration tools and equipment.

Calibration—Type 1L20

Type 1L20, Serial No. _____

Calibration Date _____

Calibrator _____

1. Preliminary Setup.....Page 6-5.

2. Adjust Dispersion.....Page 6-6.

Adjust C358 for 1 marker/centimeter. (10 MHz/CM dispersion)

Adjust R368 for 1 marker/2 centimeters. (500 kHz/CM dispersion)

Adjust C384, C385 for a centered 500 kHz/CM display.

Check kHz/CM dispersion for $\pm 3\%$ accuracy.

Check MHz/CM dispersion accuracy over full range of the IF CENTER FREQ control for:

$\pm 3\%$ at 10 MHz/CM

$\pm 3\%$ at 5 MHz/CM

$\pm 5\%$ at 2 MHz/CM

$\pm 7\%$ at 1 MHz/CM

$\pm 10\%$ at .5 MHz/CM

$\pm 15\%$ at .2 MHz/CM

3. Check Dispersion Linearity.....Page 6-8.

Check the display in all kHz/CM and MHz/CM positions for $\pm 3\%$ linearity.

4. Adjust Resolution.....Page 6-8.

Adjust C504, C508, R543, C620, L624 for 100 kHz resolution.

Check for proper 1 kHz resolution.

5. Adjust Center Frequency of Sweeper.....Page 6-10.

Adjust R253 (Center Freq Range adjust) so that the DISPERSION control setting does not affect the MHz/CM center frequency.

Adjust R368 (kHz/CM Cal adjust) so that the DISPERSION control setting does not affect the kHz/CM center frequency.

6. Check IF CENTER FREQ Control Range....Page 6-10.

DISPERSION	Coarse (10 turn)	FINE
1 kHz/CM to 500 kHz/CM	$\geq +$ & -2.5 MHz	$\geq +$ & -50 kHz
.2 MHz/CM to 5 MHz/CM	$\geq +$ & -25 MHz	$\geq +$ &
10 MHz/CM	$\geq +$ & -10 MHz	-1 MHz

7. Adjust Phase Lock Circuit.....Page 6-11.

Adjust L804 for maximum 1 MHz CAL MARKER OUT signal.

Apply 1 volt p-p 5 MHz signal to EXT FREQ IN and adjust R831 (Avalanche Volts adjust) midway between avalanche and free-run. (Minimum jitter.)

Check for voltage swing from $\leq +4$ volts to $\geq +10$ volts at Pin D as FINE FREQ control is rotated through range. Check for +7 volts at Pin D with FINE FREQ control at 0.

8. Check RF CENTER FREQ Calibration and Phase Lock

Check calibration for ± 2 MHz $\pm 1\%$ of dial reading.

Check for phase-locked display through range of analyzer.

9. Adjust Narrowband IF Amplifier Peaking..Page 6-13.

Adjust L144, C425, C435, T454, T464, L444 for maximum 200 MHz signal amplitude.

10. Adjust Wide-Band Amplifier Response....Page 6-14.

Adjust L134 and C137 for flat response to 150-250 MHz swept frequency signal.

Adjust L144 for maximum response to 200 MHz signal.

Adjust L147 for minimum response to 65 MHz signal.

11. Check Low-Pass and Bandpass Filters....Page 6-14.

Check for flat response and roll-off between 150 and 250 MHz for Bands 2-5, between 175 and 225 MHz for Band 1.

12. Adjust RF Mixers.....Page 6-15.

Adjust C14 and C16 for minimum spurious signal response.

Adjust C66 for best sensitivity and flatness.

13. Check Sensitivity and RF Frequency Range Page 6-16.

Check sensitivity with RESOLUTION control fully-clockwise for:

-80 dBm on Band 1

-90 dBm on Band 2

-80 dBm on Band 3

-75 dBm on Band 4

-70 dBm on Band 5

At the same time, check for a signal display at the extreme ends of each band.

14. Adjust and Check Dynamic Range.....Page 6-17.

Check LINear display for ≤ 26 dB dynamic range.

Adjust LOG display for ≥ 40 dB dynamic range

Check SQ LAW display for ≥ 13 dB dynamic range.

15. Check Display Flatness.....Page 6-17.

Check display for $\leq \pm 1.5$ dB flatness from 225 MHz to 275 MHz.

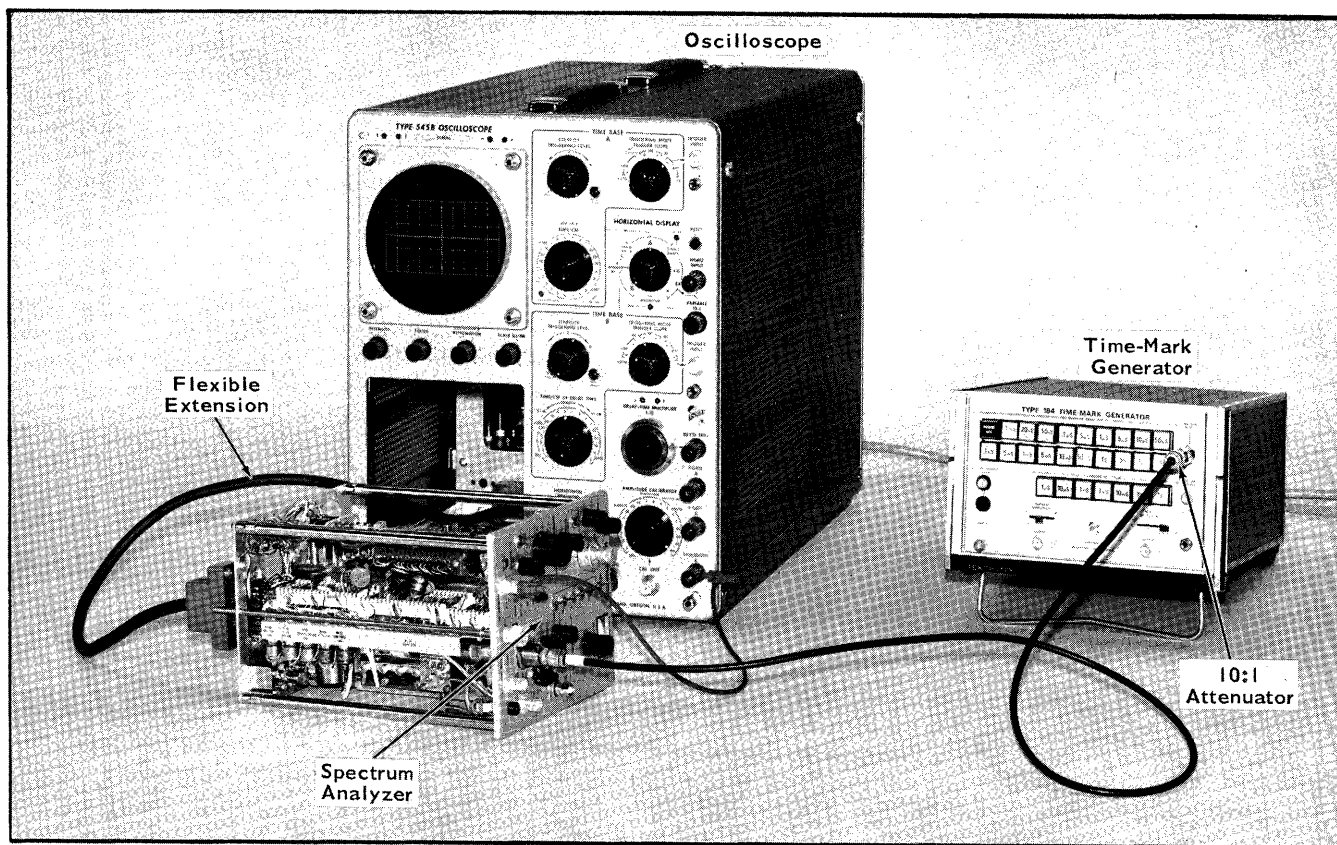

Fig. 6-3. Setup for adjusting Dispersion accuracy (Step 2).

2. Adjust Dispersion Accuracy



a. Connect the equipment as shown in Fig. 6-3.

If a Type 180A Time-Mark Generator must be used in place of the Type 184 shown, connect it to the Spectrum Analyzer as follows:

1. Connect the MARKER OUT connector of the Type 180A to the RF connector of the Harmonic Modulator Unit and depress the 50 MC pushbutton on the Type 180A.

2. Connect a cable between the desired modulation signal and the Harmonic Modulator's Modu 2 connector.

3. Connect the Harmonic Modulator's Modu Harm Out connector to the Analyzer's BANDS 2-5 RF INPUT connector.

4. Set the Modulator's controls as follows: Modu Freq 2 to ON, 60 MC Trap to Out, and the two Variable controls to the settings giving the most readable display.

b. Preset the controls of the Spectrum Analyzer as follows:

POS	Position the trace to the bottom line of the graticule
IF ATTEN	All Off
FINE IF CENTER FREQ	Midrange (000)
IF CENTER FREQ	Midrange

IF CENTER FREQ CAL	Centered (Screwdriver Adjustment)
DISPERSION RANGE	MHz/CM
DISPERSION—COUPLED RESOLUTION	10 (Outer ring)
Video Filter	Off (Down)
VERTICAL DISPLAY	LOG
RF INPUT	BANDS 2-5

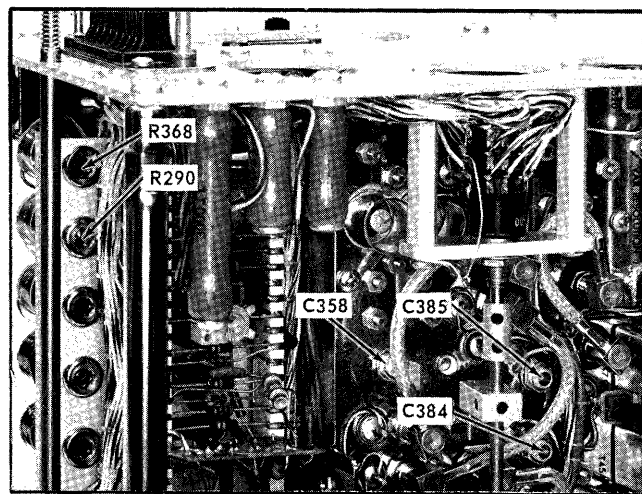

Fig. 6-4. Location of Dispersion adjustments (Steps 2 and 3).

c. Depress the MARKER SELECTOR switches for 10 μ S (100 MHz) and .1 μ S (10 MHz).

d. Adjust the Spectrum Analyzer GAIN control for a display about 5 centimeters in amplitude.

e. Adjust C358 (see Fig. 6-4) for 1 marker/centimeter over the middle eight centimeters of the display. If the dispersion seems non-linear, readjust R290 (IF CF Range) while adjusting C358 to obtain the best dispersion and linearity. Monitor Pin P with a test oscilloscope to keep the voltage at this pin between -0.8 and -1.2 volts.

f. Change the DISPERSION to 500 kHz/CM. Apply a 1 MHz signal from the Time-Mark Generator.

g. Adjust R368 (see Fig. 6-4) for 1 marker/2 centimeters.

h. If the display is not centered, adjust C384 and C385 (see Fig. 6-4) so that it is centered. If necessary, readjust R368 for the correct dispersion again.

i. Check the kHz/CM DISPERSION linearity at the ends of the IF CENTER FREQ range. With a marker at the first graticule line, the fifth marker should be within 3 millimeters of the ninth graticule line.

j. If the 500 kHz/CM is not within these specifications, turn C384 and C385 very slightly in opposite directions so as to keep the display centered, readjust R368 for 1 marker/2 centimeters, and recheck the dispersion at the ends of the IF CENTER FREQ range. Repeat this procedure until the dispersion accuracy is within specifications at both ends of the IF CENTER FREQ range.

k. Center the IF CENTER FREQ control and check the dispersion accuracy at each DISPERSION/CM setting, using Table 6-1. Position a modulation mark at the first graticule line and check the displacement of the ninth marker from the ninth graticule line for displays having 1 division/

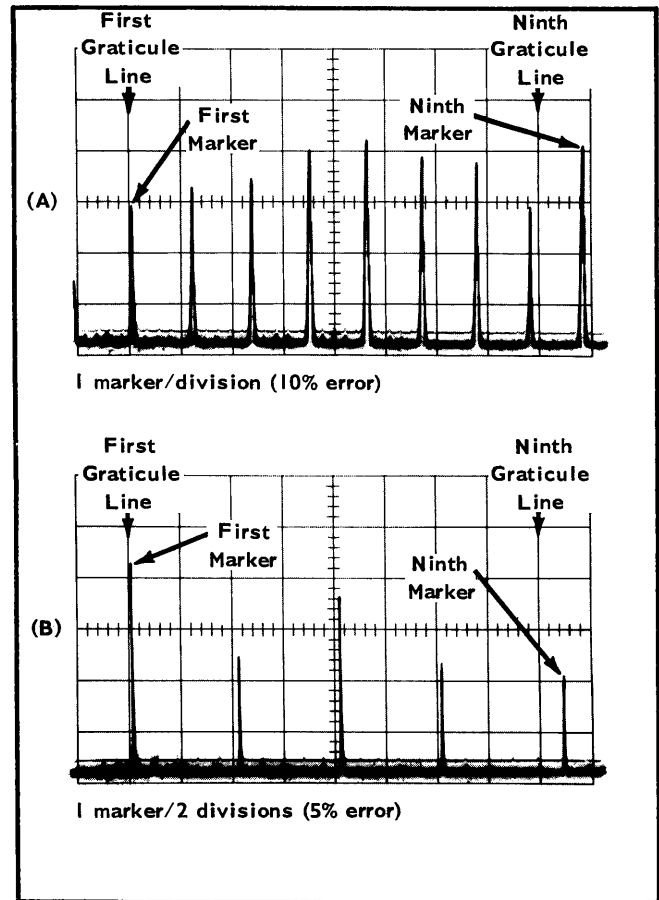

Fig. 6-5. Typical Dispersion accuracy displays (Step 2).

marker. If the display should have 2 divisions/marker, then check the displacement of the fifth marker from the ninth line. (See Fig. 6-5.)

TABLE 6-1

DISPERSION/CM	Modulation Signal	CRT Display in Divisions/Marker	Maximum Error	Notes
10 MHz	.1 μ S (10 MHz)	1	$\pm 3\%$	Check With IF CENTER FREQ control centered
5 MHz	.1 μ S (10 MHz)	2	$\pm 3\%$	
2 MHz	.5 μ S (2 MHz)	1	$\pm 5\%$	Over range of IF CENTER FREQ control (± 25 MHz)
1 MHz	1 μ S (1 MHz)	1	$\pm 7\%$	
.5 MHz	1 μ S (1 MHz)	2	$\pm 10\%$	$\pm 3\%$
.2 MHz	5 μ S (200 kHz)	1	$\pm 15\%$	
500 kHz	1 μ S (1 MHz)	2		
200 kHz	5 μ S (200 kHz)	1		
100 kHz	10 μ S (100 kHz)	1		
50 kHz	10 μ S (100 kHz)	2		
20 kHz	50 μ S (20 kHz)	1		
10 kHz	.1 mS (10 kHz)	1		
5 kHz	.1 mS (10 kHz)	2		
2 kHz	.5 mS (2 kHz)	1		
1 kHz	1 mS (1 kHz)	1		

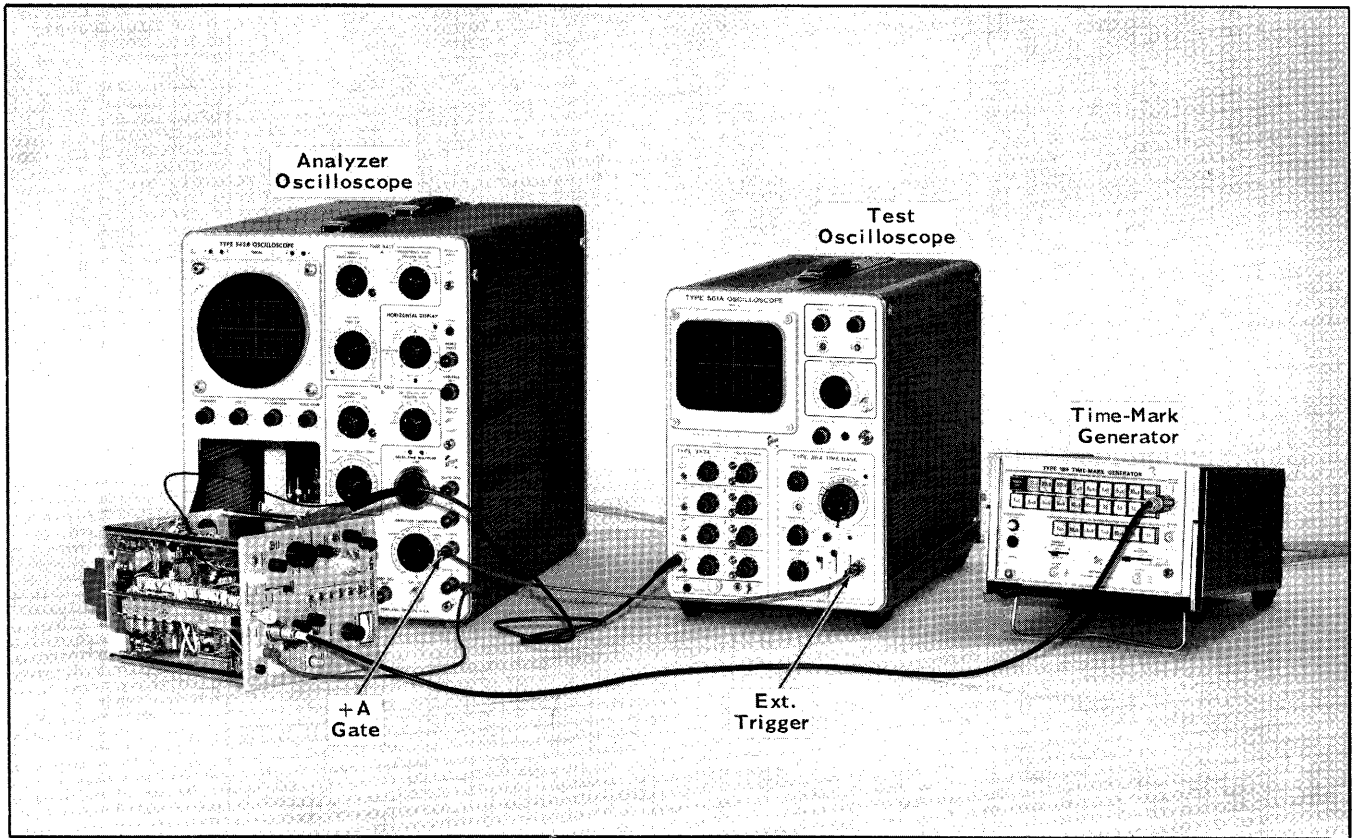

Fig. 6-6. Setup for adjusting Resolution (Step 4).

3. Check Dispersion Linearity

a. Set up the equipment as directed in Steps 2a through 2d.

b. At each DISPERSION/CM setting of Table 6-1, readjust the front-panel DISP CAL adjustment to align markers with the first and ninth graticule lines. (See Fig. 6-5.) The IF CENTER FREQ controls may be rotated slightly away from center to position a marker at the first graticule line.

c. All markers between the first and ninth graticule lines should be within 2.4 millimeters of the appropriate graticule lines.

4. Adjust Resolution

a. Connect the equipment as shown in Fig. 6-6. (The test oscilloscope probe is on Pin B of the IF Chassis square-pin connector board.)

b. Preset the controls of the Spectrum Analyzer as follows:

POS	Position the trace to the bottom line of the graticule
IF ATTEN	All OFF
DISPERSION RANGE	kHz/CM
DISPERSION	50

RESOLUTION	Fully Clockwise
VIDEO FILTER	Off (Down)
VERTICAL DISPLAY	LIN
RF INPUT	BANDS 2-5

c. Set the Analyzer oscilloscope sweep to 20 mS/CM; set the test oscilloscope sweep rate to 50 mS/CM; and set the Time-Mark Generator for a 200 MHz signal.

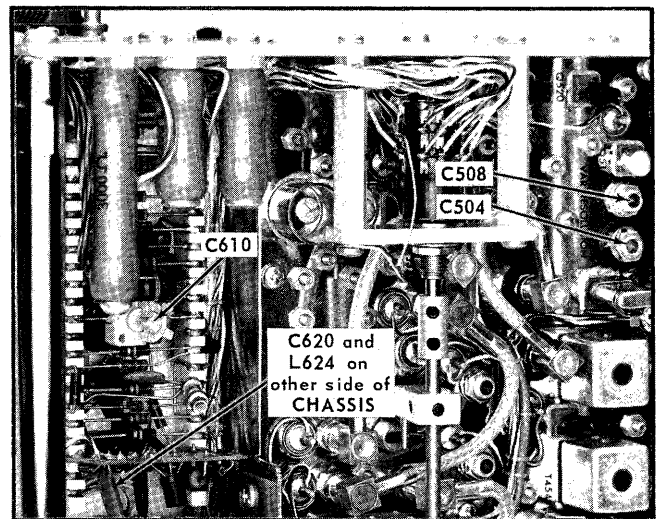

Fig. 6-7. Location of Resolution adjustments (Step 4).

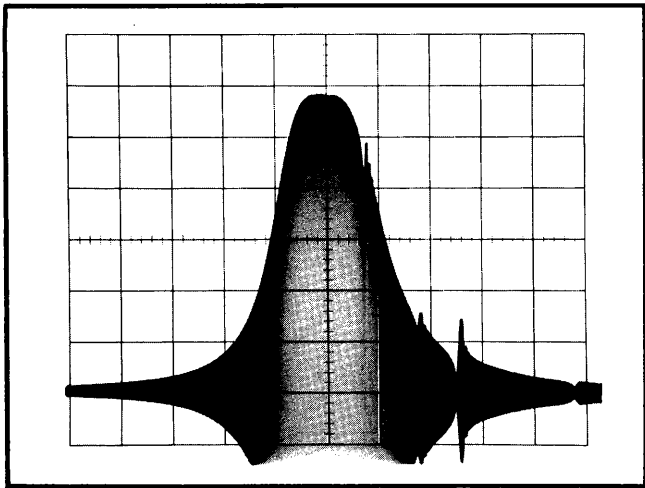

Fig. 6-8. Typical test oscilloscope display for adjusting C504 and C508 (Step 4).

d. See Fig. 6-7 for the location of the adjustments called out below.

e. Adjust C504 and C508 for a display on the test oscilloscope similar to Fig. 6-8. Set C504 for minimum display width at 1 centimeter above the base line and set C508 for the most symmetrical display. Touch up the settings of C504 for the best symmetry. When the capacitors are properly set, the display on the test oscilloscope will be approximately symmetrical at each position of the RESOLUTION control. Remove the test probe.

f. Adjust C610 for equal curves at the base of the spectrum display (see Fig. 6-9).

g. Adjust C620 and L624 for a symmetrical waveform. Recheck adjustment of C610.

h. Turn the RESOLUTION knob to the next counterclockwise position.

i. Adjust R543 (100 kHz Resol Cal) for a signal 1.2 centimeters wide at 3 centimeters above the baseline. See Fig. 6-10. (Adjust the GAIN control for 6 centimeters display during this step.)

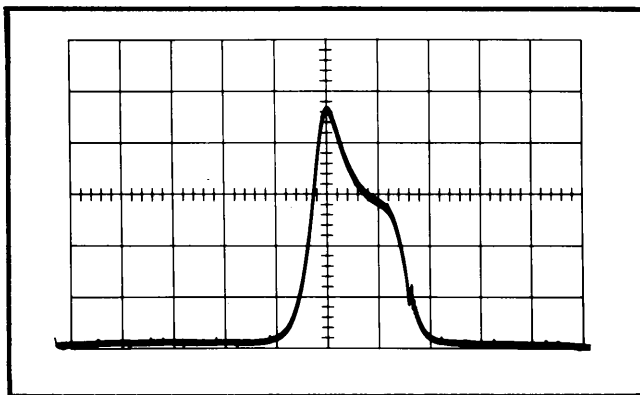

Fig. 6-9. Typical spectrum display for adjusting C610 (Step 4).

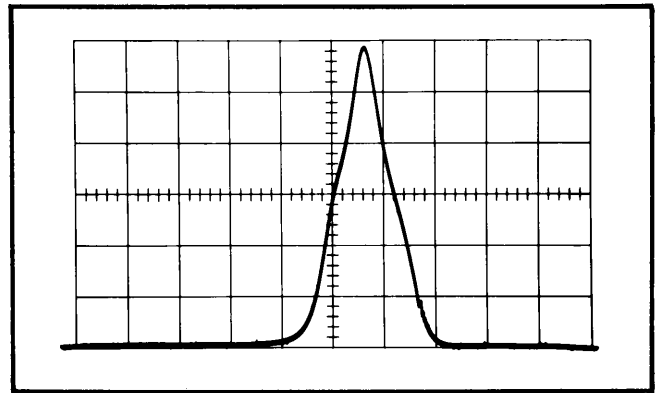

Fig. 6-10. Typical spectrum display for adjusting R543 (Step 4).

j. There is considerable interaction between the above steps, so return the RESOLUTION control to the clockwise position and repeat Steps e through j until the displays are satisfactory.

k. When properly calibrated, the resolution waveform should be 100 kHz wide at 3 centimeters above the baseline when the RESOLUTION control is turned fully clockwise and should become narrower at each step as the control is turned counterclockwise. At the fully counterclockwise position, the resolution should not be more than 1 kHz wide at 3 centimeters above the baseline. (See Fig. 6-11).

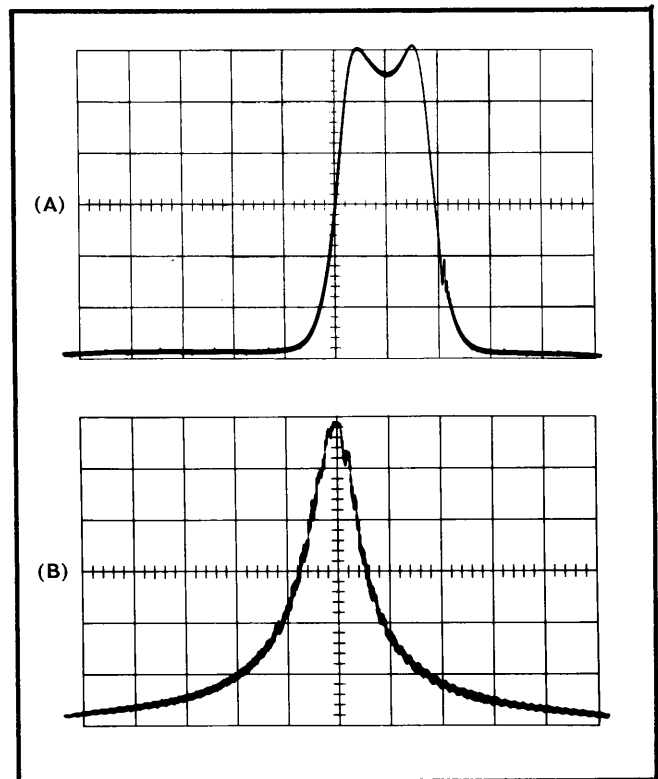

Fig. 6-11. Typical spectrum display for final Resolution adjustments (Step 4).

(B) 1 kHz Resolution.

(A) 100 kHz Resolution.

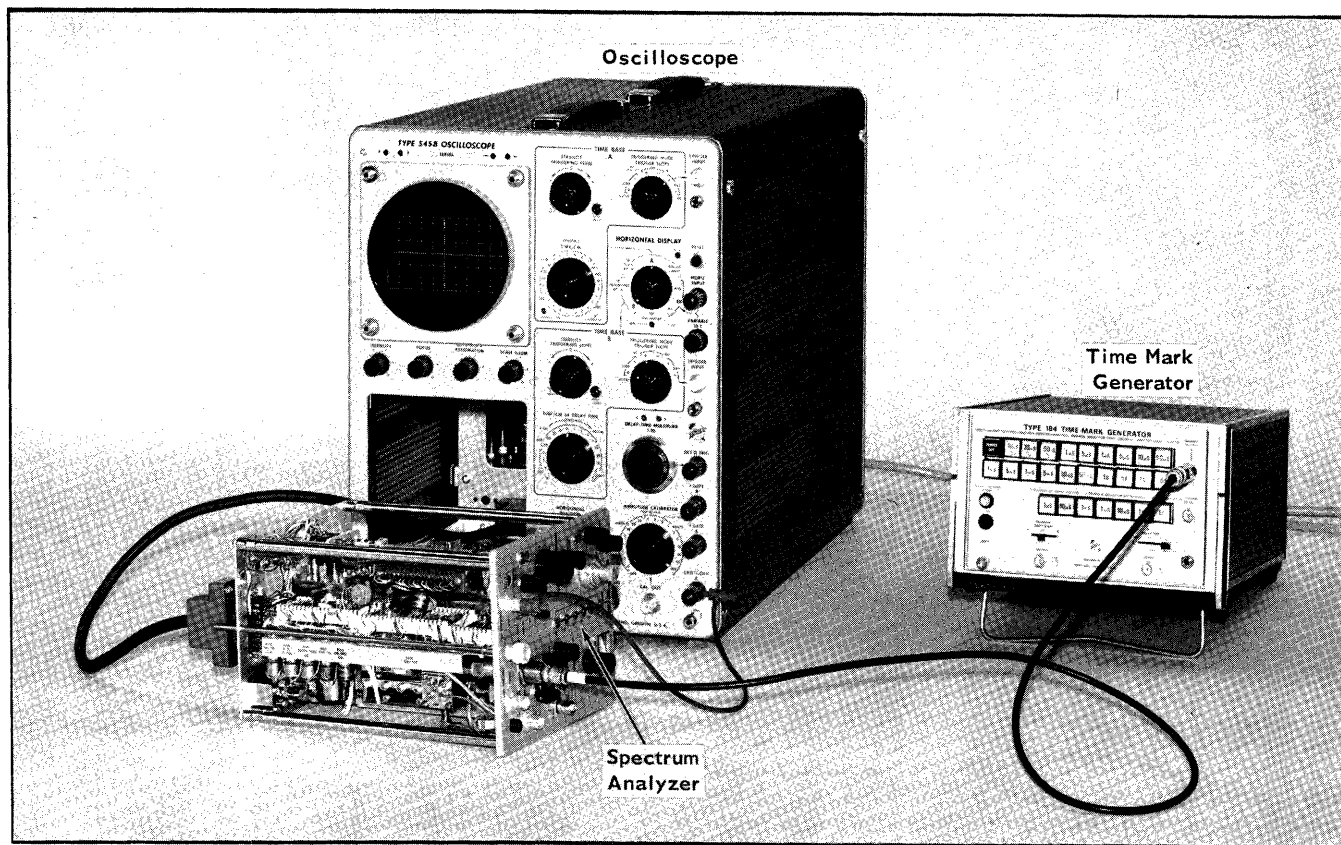

Fig. 6-12. Setup for adjusting Swept Frequency Oscillator Center Frequency (Step 5) and checking range of IF CENTER FREQ Controls (Step 6).

5. Adjust Center Frequency of Swept Frequency Oscillator

- a. Connect the equipment as shown in Fig. 6-12.
- b. Preset the front-panel controls as follows:

Horizontal Position (Oscilloscope)	Center the trace on the center of the graticule
POS	Position the trace to the bottom line of the gra- ticule
IF CENTER FREQ	Midrange (000)
FINE IF CENTER FREQ	Midrange
DISPERSION RANGE	MHz/CM
VERTICAL DISPLAY	LIN
IF CENTER FREQ CAL (Screwdriver Adjust)	Centered

- c. Apply a 100 MHz signal from the generator.

d. Adjust the Center Freq. Range control R253 (see Fig. 6-13) so that the IF feed-through signal does not shift in position as the DISPERSION—COUPLED RESOLUTION control is rotated.

e. Set the DISPERSION—COUPLED RESOLUTION control to 10 and adjust R204 to center the display.

- f. Change the DISPERSION RANGE to kHz/CM.

g. Adjust R368 (kHz/CM Cal) so that the signal does not shift in position when the DISPERSION—COUPLED RESOLUTION control is rotated between 500 kHz/CM and 20 kHz/CM. Significant changes in the setting of R368 will affect the accuracy of the kHz/CM Dispersion. If R368 is changed be sure to recheck the adjustment of C384 and C385 (See Steps 2h through 2j).

6. Check Range of IF CENTER FREQ Controls

- a. Preset the controls on the Spectrum Analyzer as follows:

POS	Position the trace to the bottom line of the gra- ticule
IF CENTER FREQ	Midrange (000)
FINE IF CENTER FREQ	Midrange
DISPERSION RANGE	MHz/CM
DISPERSION— COUPLED RESOLUTION	10
VERTICAL DISPLAY	LOG

- b. Connect the equipment as shown in Fig. 6-12. Set the generator for 100 MHz and 10 MHz markers.

- c. Adjust the GAIN control so that the 10 MHz markers are visible.
- d. The second harmonic of the 100 MHz signal should be centered on the graticule; if it is off-center, readjust R253 and R204 as directed in Step 5.
- e. Rotate the 10-turn IF CENTER FREQ control to both ends of its range. The markers must move at least 1 centimeter (10 MHz) from center in each direction.
- f. Change the DISPERSION to 5 MHz/CM.
- g. Rotate the 10-turn IF CENTER FREQ control through its range. The markers must move at least 25 MHz from center in each direction.
- h. Center the 10-turn control and rotate the FINE IF CENTER FREQ control to the ends of its rotation. The markers must move at least 1 MHz in each direction.
- i. Change the DISPERSION to 500 kHz/CM.
- j. Rotate the 10-turn IF CENTER FREQ control to the ends of its rotation. The markers must move at least 2.5 MHz from center in each direction.
- k. Center the 10-turn control and rotate the FINE IF CENTER FREQ control to both ends of its rotation. The markers must move at least 50 kHz in each direction.

7. Adjust Phase Lock Circuit



- a. Preset the controls of the Analyzer as follows:

POS	Position the trace to the bottom line of the graticule
IF ATTEN	All OFF
IF CENTER FREQ	Midrange (000)
FINE IF CENTER FREQ	Midrange
DISPERSION RANGE	MHz/CM
DISPERSION—	1
COUPLED RESOLUTION	
VERTICAL DISPLAY	LIN
INT 1 MHz REF FREQ	Up

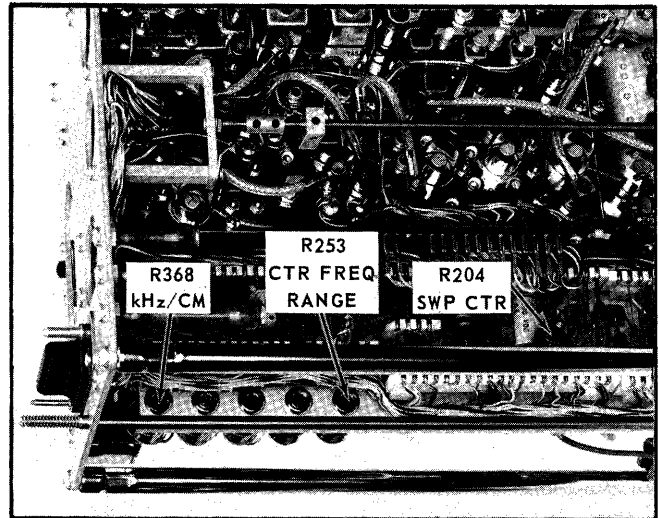

Fig. 6-13. Location of Center Frequency adjustments.

- b. Connect the 1 MHz REF FREQ signal to the test oscilloscope Vertical Input. Use 1 μ s/division sweep rate; 0.01 or 0.005 volts/division sensitivity.
- c. Adjust L804 (located about two inches behind the 1 MHz REF FREQ connector) for maximum signal amplitude. Adjust L804 slowly, the correct setting is easy to miss.
- d. Turn the INT 1 MHz REF FREQ signal on and off several times. The signal should reappear each time with no delay. Readjust L804 if necessary.
- e. Apply a 1 volt 5 MHz signal to the EXT FREQ IN connector and adjust R831 (Avalanche Volts) midway between avalanche and free run.
- f. Connect the test oscilloscope to Pin D of the Phase Lock square-pin connector board, set the INT 1 MHz REF FREQ switch to Off, and check for a voltage swing from $\leq +4$ volts to $\geq +10$ volts as the FINE FREQ control is rotated through its range.
- g. Set the FINE FREQ control for +7 volts at Pin D. The knob should be at 0. Reset the knob on its shaft if necessary.

NOTES

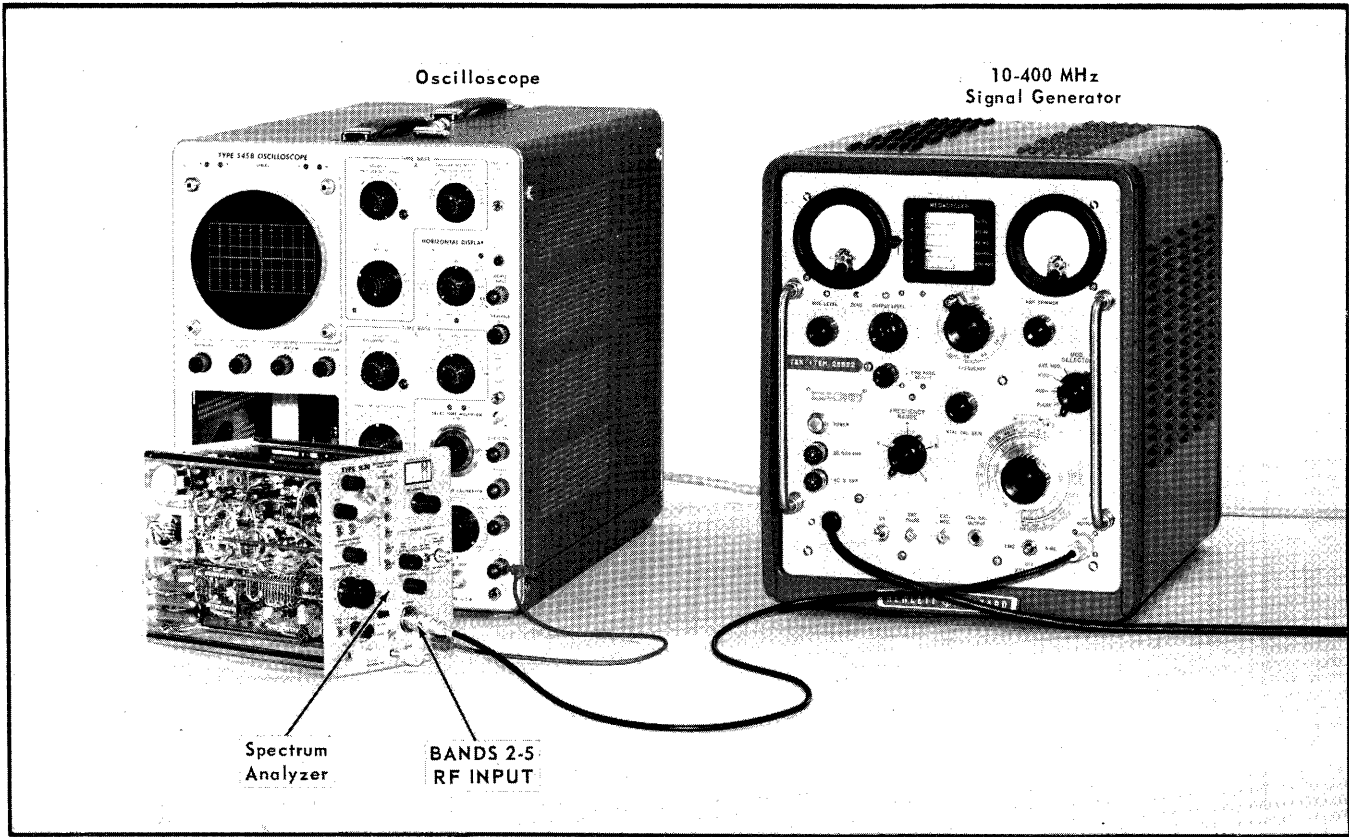

Fig. 6-14. Setup for checking RF CENTER FREQ Calibration and Phase Lock (Step 8).

8. Check RF CENTER FREQ Calibration and Phase Lock Display

NOTE

If the following procedure indicates that the Local Oscillator frequency calibration is out of tolerance, the instrument should be returned to Tektronix for recalibration—see page 4-1.

- a. Connect the equipment as shown in Fig. 6-14.
- b. Preset the front-panel controls of the analyzer as directed in Step 7a.
- c. Check the Band 1 frequency calibration every 10 MHz by applying the appropriate -70 dBm signals. Maximum dial error for this step (and c, d, and e following) is ± 2 MHz $+1\%$ of the dial reading.

At the same time, while changing the RF CENTER FREQ control setting, depress the LOCK CHECK pushbutton and

check for phase-lock zero beats about every 1 MHz. Check for a phase-locked display at 10 MHz, 100 MHz, and 270 MHz.

d. Move the generator output to the BANDS 2-5 RF INPUT connector and check the dial accuracy every 100 MHz from 275 MHz to 475 MHz. Check the phase-lock zero beats as before, and check for a phase-locked display at 275 MHz and 500 MHz.

e. Check the dial accuracy at 500 MHz, 700 MHz, and 900 MHz, using the second harmonic of the signal generator. Check for zero beats as before and check for a phase-locked display at 900 MHz.

f. Since Bands 3, 4, and 5 use harmonics of the frequencies checked in d and e above, it follows that if the dial calibration of Band 2 is within specifications, Bands 3, 4 and 5 will also be within specifications.

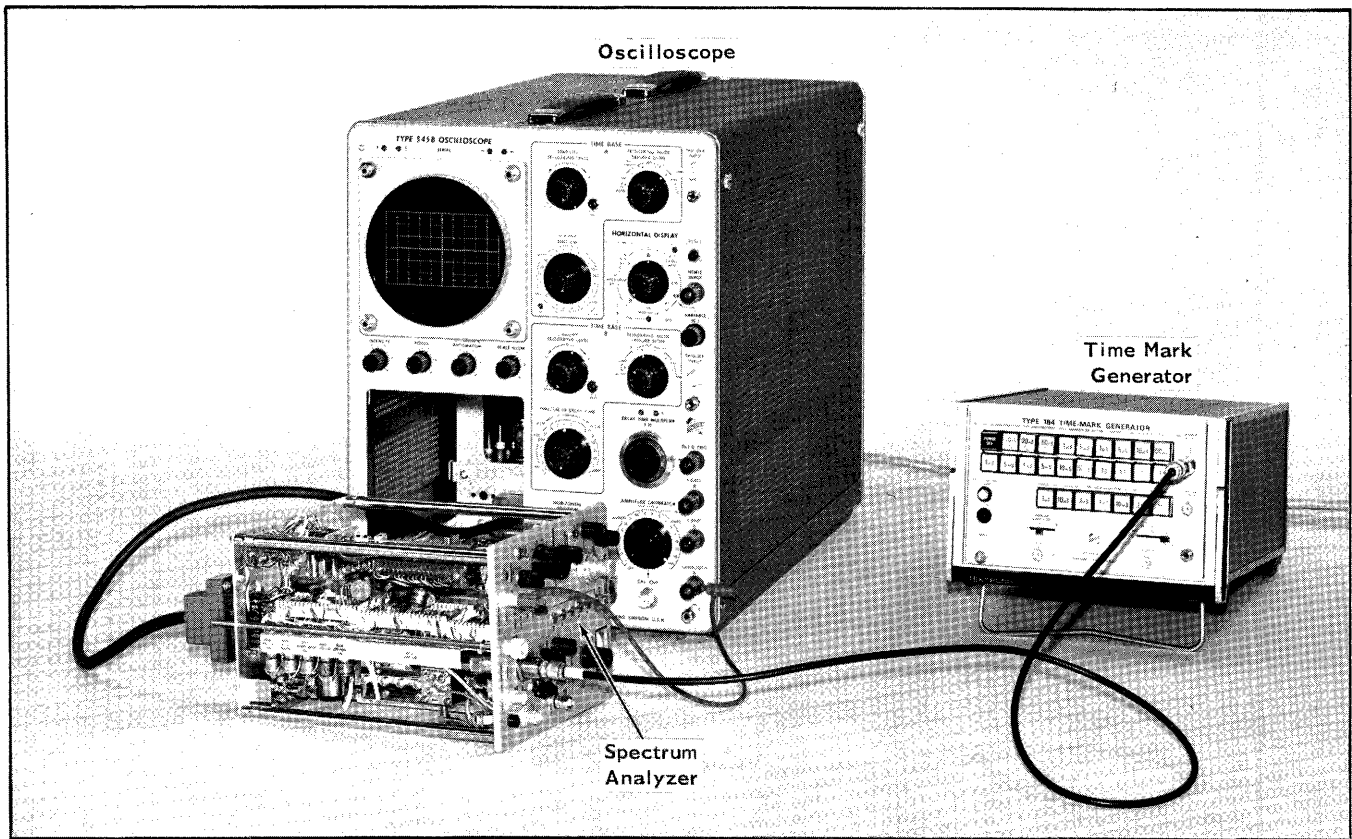

Fig. 6-15. Setup for adjusting IF Amplifier Response (Step 9).

9. Adjust Narrow-Band IF Amplifier Peaking ①

- a. Connect the equipment as shown in Fig. 6-15.
- b. Preset the front panel controls of the Analyzer as follows:

POS	Position the trace to the bottom line of the graticule
IF ATTEN	20 dB On
DISPERSION RANGE	kHz/CM
DISPERSION—COUPLED RESOLUTION	5 (Outer Ring)
GAIN	Fully Clockwise
VIDEO FILTER	Off (Down)
VERTICAL DISPLAY	LIN
RF INPUT	BANDS 2-5
- c. Set the generator for a 200 MHz signal.
- d. Set the Generator Output controls for a 4 centimeter display times the noise level.
- e. Peak up C425, C435, T454, T464 and L444 (see Fig. 6-16) for maximum signal amplitude. (Make sure L444 is set to give

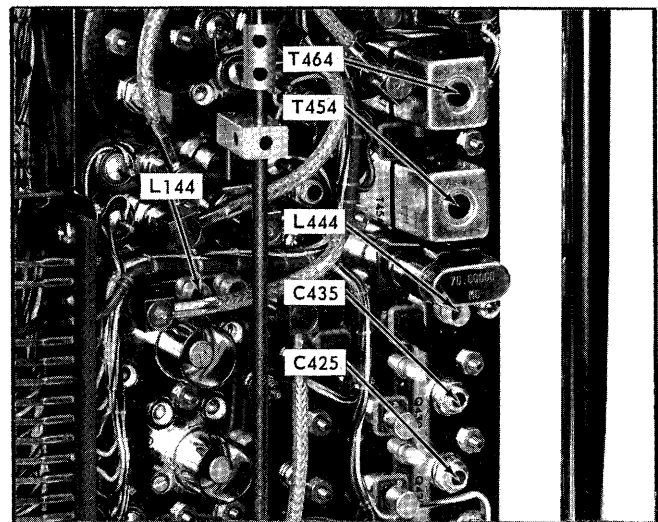

Fig. 6-16. Location of IF Amplifier adjustments (Step 9).

a stable 70 MHz oscillation. This will usually be about one-fourth of a turn below the peaked setting.)

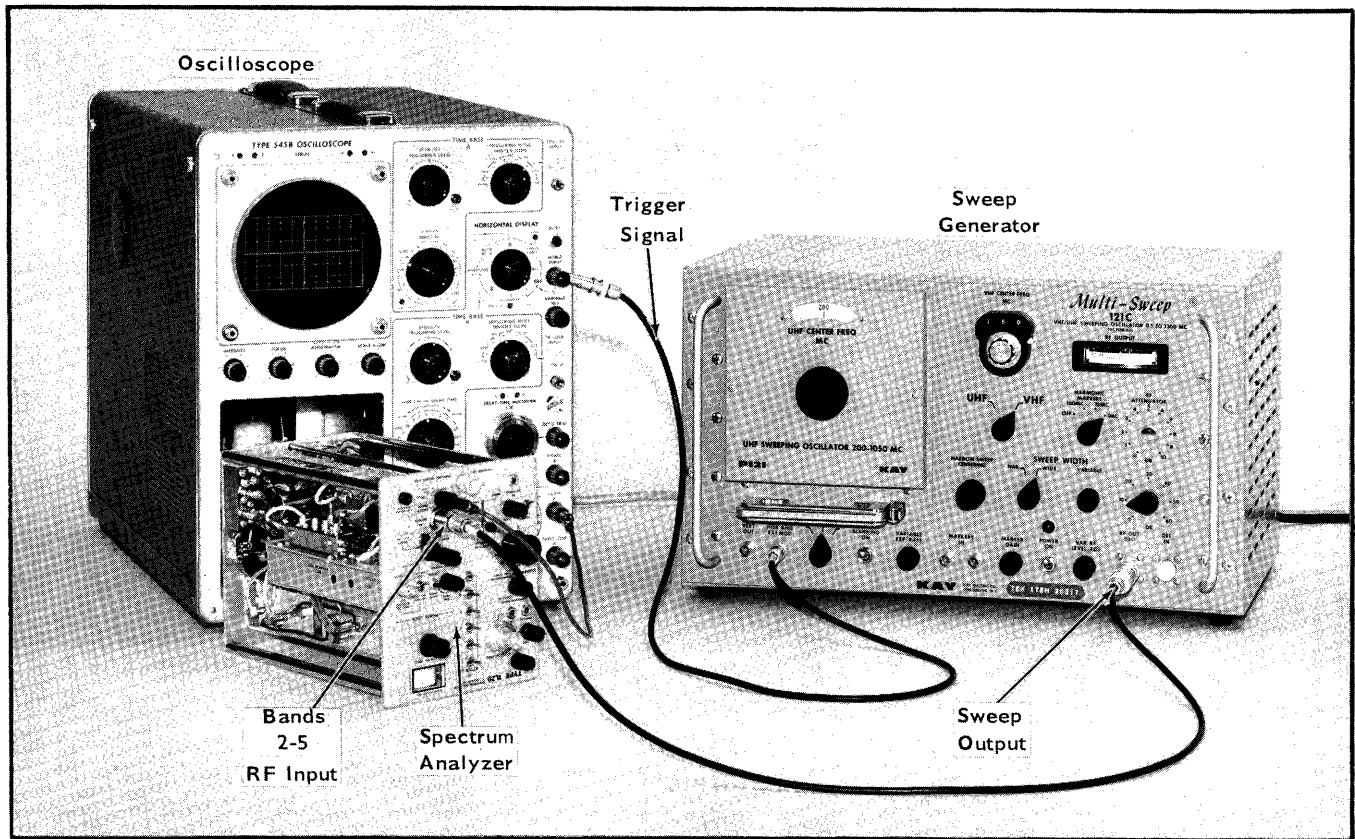

Fig. 6-17. Setup for adjusting Wide-Band Amplifier (Step 10) and checking the Low Pass and Band Pass Filters (Step 11).

10. Adjust Wide-Band Amplifier Circuit ①

a. Inside the Spectrum Analyzer, connect the Band 1 Mixer to the Wide Band Amplifier. This can be accomplished by moving the cable normally connecting J94 to J100 so that it connects J69 to J120 instead.

b. Connect the equipment as shown in Fig. 6-17.

c. Preset the controls of the Spectrum Analyzer as follows:

POS	Position the trace to the bottom line of the graticule.
DISPERSION RANGE	MHz/CM
DISPERSION—	
COUPLED RESOLUTION	10
VIDEO FILTER	Off (Down)
VERTICAL DISPLAY	LIN

d. Set the Sweep Generator so that it sweeps from 150 MHz to 250 MHz.

e. Set the signal amplitude and the GAIN control to give about 4 centimeters of vertical deflection.

f. Set the IF CENTER FREQ control so that the display is centered on the CRT.

g. Adjust L134 and C137 (see Fig. 6-18) for the best flatness between 150 MHz and 250 MHz.

h. Disconnect the sweep generator signal and apply a -40 dBm 74 MHz signal in its place.

i. Set the IF CENTER FREQ control so that the display is centered on the CRT.

j. Adjust L144 (see Fig. 6-18) for maximum display amplitude.

k. Change the signal frequency to 65 MHz.

l. Recenter the display with the IF CENTER FREQ control.

m. Adjust L147 (see Fig. 6-18) for minimum display amplitude.

n. Change the cables (see Step 10a) back to the original layout.

11. Check Lowpass and Bandpass Filters

a. Set up the equipment as directed in Steps 10a through 10f.

b. Check the display does not vary in amplitude more than 0.5 centimeters between 150 MHz and 250 MHz.

c. Change the RF INPUT switch to BAND 1 and change the signal cable to the BAND 1 connector.

d. Check that the display does not vary in amplitude more than 0.5 centimeters between 175 MHz and 225 MHz.

NOTE

If steps c and d indicate that the Lowpass or Band-pass Filters need readjustment, the Analyzer should be returned to Tektronix for checking, since calibration of these filters requires partial disassembly of the unit and special test setups and equipment. Normally, the filters will not need recalibration unless some of the circuit components have been changed or damaged.

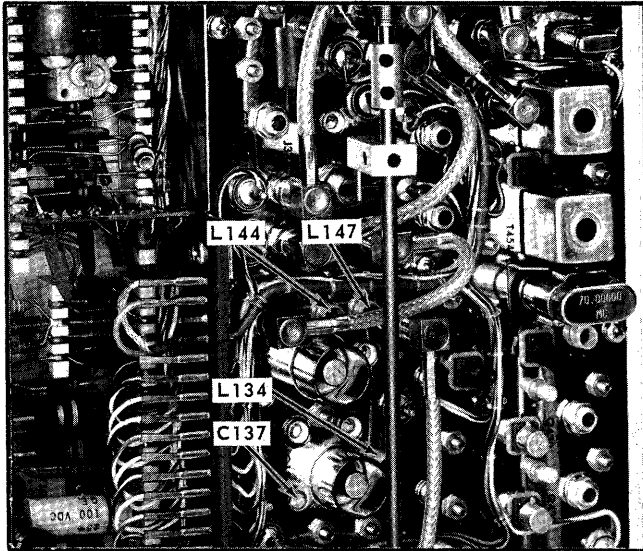

Fig. 6-18. Location of Wide-Band Amplifier Adjustments (Step 10).

12. Adjust RF Mixers



- a. Preset the Analyzer controls as directed in Step 10c.
- b. With no signal being applied, slowly turn the RF CENTER FREQ control through its range. There should be no spurious signals greater in amplitude than twice the noise level.
- c. If a spurious signal is observed, position it to the center of the CRT and adjust C14 and C16 (see Fig. 6-20) for minimum amplitude.

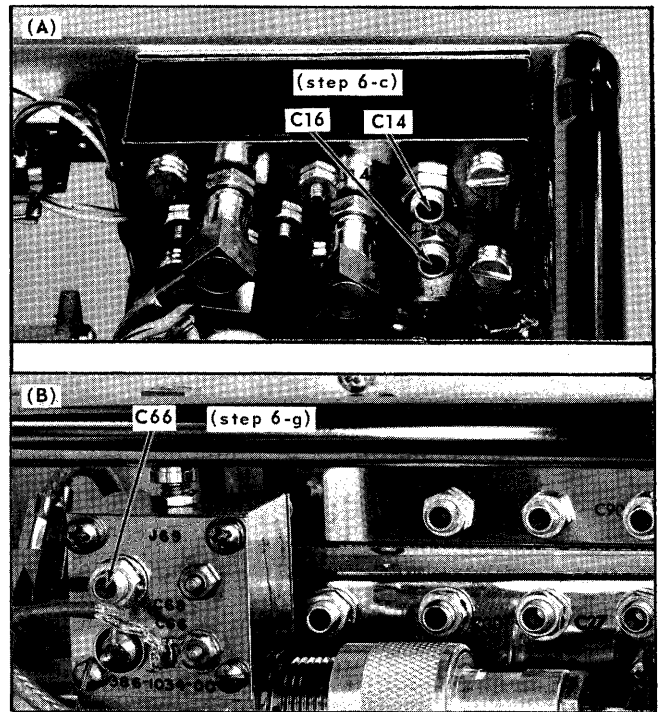

Fig. 6-19. Location of RF Mixer adjustments (Step 12).

ness while turning the RF CENTER FREQ control to move the signal from one side of the graticule to the other.

- d. Apply an 800 MHz signal from the RF Signal Generator to the BANDS 2-5 RF INPUT connector and change the RF INPUT switch to BANDS 2-5.
- e. Center the signal on the CRT with the RF CENTER FREQ control.
- f. Adjust the RF PEAKING control for maximum signal amplitude.
- g. Adjust C66 (see Fig. 6-19) for best sensitivity and flat-

NOTES

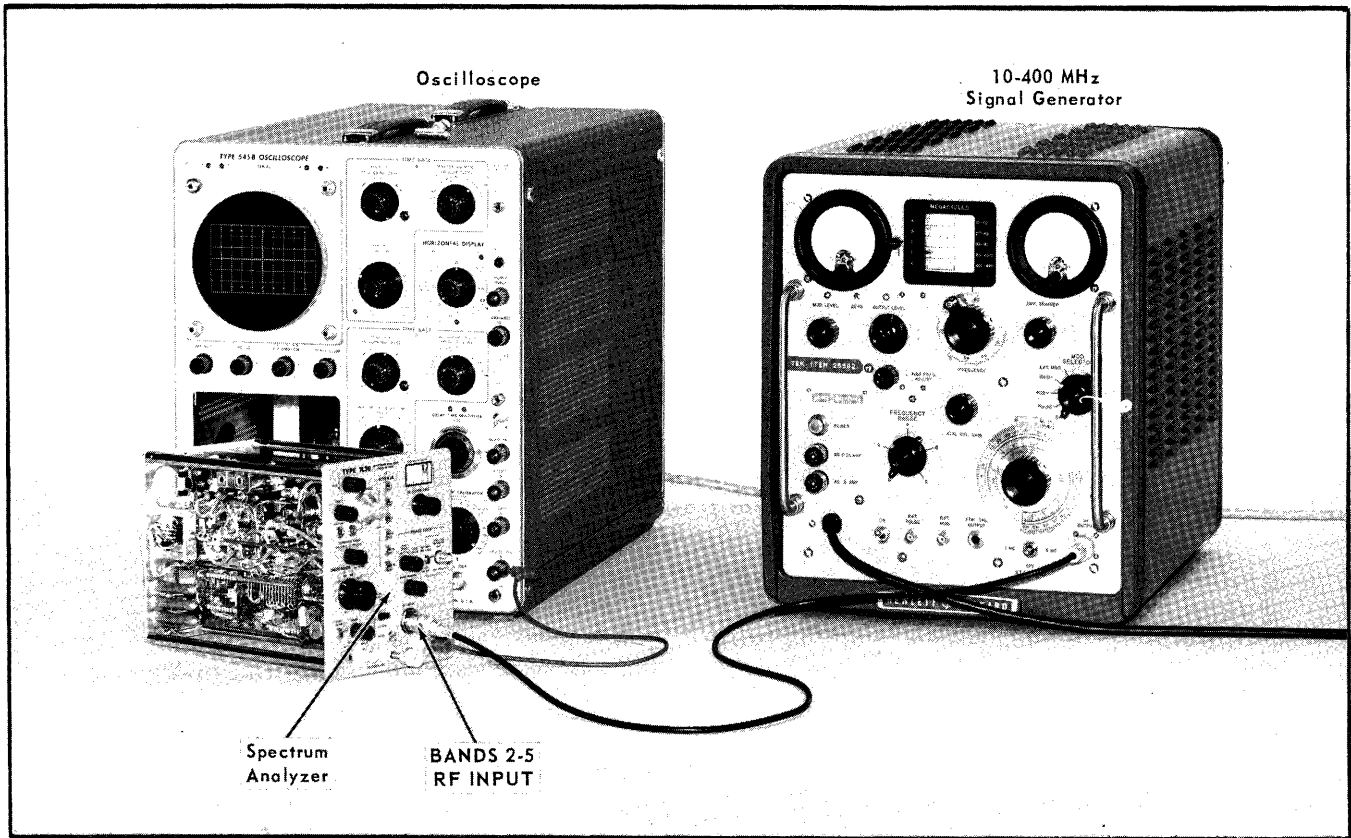

Fig. 6-20. Setup for Steps 13 through 16.

13. Check Sensitivity and RF Frequency Range

- a. Connect the equipment as shown in Fig. 6-20.
- b. Preset the controls of the Spectrum Analyzer as follows:

POS	Position the trace to the bottom line of the graticule
IF ATTEN	All OFF
DISPERSION RANGE	kHz/CM
DISPERSION—COUPLED RESOLUTION	5
VIDEO FILTER	Off (Down)
VERTICAL DISPLAY	LIN
RF INPUT	BAND 1
RF CENTER FREQ	10
FINE FREQ	Fully Clockwise

c. Apply a -30 dBm 10 MHz signal from the UHF Signal Generator to the BAND 1 RF INPUT connector.

d. Center the signal on the graticule with the Frequency control of the signal Generator.

e. Adjust the Analyzer GAIN control until the average noise level is one centimeter in amplitude.

f. Adjust the RF Atten control of the generator so that the displayed signal is twice as high as the noise level. (See Fig. 6-21).

g. Check the setting of the RF Atten dial of the generator. It should read -90 dBm or less.

h. Check the sensitivity over the rest of the frequency range of the Analyzer as directed in Table 6-2. On Bands 2-5, readjust the Analyzer MIXER PEAKING control for maximum signal amplitude whenever the frequency is changed.

TABLE 6-2

Suggested Signal Generator (Refer to Recommended Equipment List)	Frequency in MHz	Band	Sensitivity
Type 608D	10	1	-80 dBm
	140		
	275		
Type 612	275	2	-90 dBm
	400		
Type 8614	900	3	-80 dBm
	850		
	1500		
Type 8616	2000	4	-75 dBm
	1950		
	2500		
	3100		
Type 8616	3000	5	-70 dBm
	3500		
	4200		

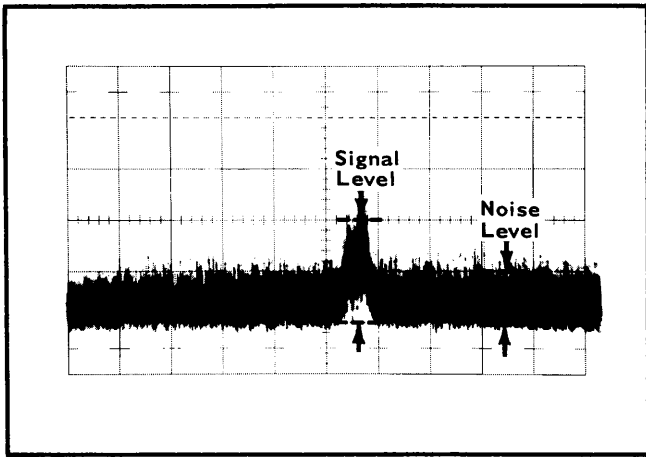

Fig. 6-21. Typical display for Sensitivity check (Step 13).

i. When the 100 kHz RESOLUTION display meets the sensitivity requirements given in Table 6-2, the 1 kHz RESOLUTION display will also be within its sensitivity requirements.

14. Adjust and Check Dynamic Ranges ❶

- a. Connect the equipment as shown in Fig. 6-20.
- b. Preset the controls of the Spectrum Analyzer as follows:

POS	Position the trace to the bottom line of the graticule
IF ATTEN	All OFF
DISPERSION RANGE	MHz/CM
DISPERSION—COUPLED RESOLUTION	1 (Outer Ring)
VIDEO FILTER	Off (Down)
GAIN	Fully counterclockwise
VERTICAL DISPLAY	LIN
RF INPUT	BAND 1

- c. Set the generator for a 200 MHz signal.
- d. Set the generator RF ATTEN control for a 6 centimeter signal amplitude.
- e. Decrease the generator output by 50 dB and turn the Analyzer GAIN control fully clockwise. Check for at least 6 centimeters of signal amplitude. Reduce the generator output by 26 dB. The signal should still be visible.
- f. Change the VERTICAL DISPLAY to LOG.
- g. Set the generator RF ATTEN to -100 dBm and adjust the Analyzer GAIN control for 2 mm signal.
- h. Set the generator RF ATTEN to -60 dBm and set the Log Cal adjust R666 (see Fig. 6-22) for a 6 centimeter signal.
- i. Return the generator RF Atten to -100 dBm. The signal should still be visible.
- j. Change the VERTICAL DISPLAY to SQ LAW.
- k. Set the generator RF Atten to -50 dBm.

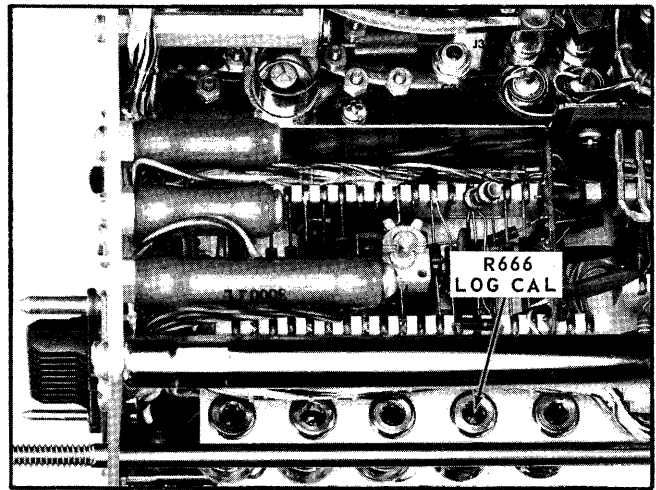

Fig. 6-22. Location of Log Cal Adjustment R666 (Step 14).

- l. Set the Analyzer GAIN control for a 6 centimeter display.
- m. Set the generator RF Atten to -63 dBm. The signal should still be visible.

15. Check Display Flatness

- a. Set up the equipment as shown in Fig. 6-20.
- b. Preset the Spectrum Analyzer controls as follows:

POS	Position the trace to the bottom line of the graticule
IF CENTER FREQ	Midrange (000)
IF ATTEN	All OFF
DISPERSION RANGE	MHz/CM
DISPERSION—COUPLED RESOLUTION	10
VIDEO FILTER	Off (Down)
VERTICAL DISPLAY	LIN
RF INPUT	BAND 1
RF CENTER FREQ	250 MHz
FINE FREQ	Fully Clockwise

- c. Set the generator for a -50 dBm 250 MHz signal.
- d. Set the Analyzer GAIN control for a 5 centimeter signal display.
- e. Turn the RF CENTER FREQ control from 225 MHz to 275 MHz and set at the frequency giving the highest amplitude signal.
- f. Set the Analyzer GAIN control for a 6 centimeter signal display.
- g. Set the 1 dB and 2 dB IF ATTEN switches to On and note the display size. Return the IF ATTEN switches to OFF.
- h. Tune the RF CENTER FREQ from 225 MHz to 275 MHz and check that the signal display does not drop below the size noted in step f.

Calibration—Type 1L20

- i. Apply a -50 dBm 350 MHz signal from the signal generator to the BANDS 2-5 RF INPUT connector and change the RF INPUTS switch to BANDS 2-5.
- j. Set the RF CENTER FREQ dial to 350 MHz.
- k. Set the MIXER PEAKING CONTROL for a maximum signal.
- l. Set the Analyzer GAIN control for a 5 centimeter display.
- m. Turn the RF CENTER FREQ control from 300 MHz to 400 MHz and set at the frequency giving the highest amplitude signal.
- n. Set the Analyzer GAIN control for a 6 centimeter signal display.
- o. Set the 1 dB and 2 dB IF ATTEN switches to On and note the display size. Return the IF ATTEN switches to OFF.
- p. Tune the RF CENTER FREQ from 300 MHz to 400 MHz and check that the signal display does not drop below the display size noted in step o.

16. Check IF Attenuator Accuracy

- a. Set up the equipment as shown in Fig. 6-20.
- b. Preset the controls of the Spectrum Analyzer as follows:

DISPERSION RANGE MHz/CM

DISPERSION— 1
 COUPLED RESOLUTION
 VIDEO FILTER Off (Down)
 VERTICAL DISPLAY LIN
 RF INPUT BAND 1
 IF ATTEN All OFF

- c. Set the generator for a -70 dBm 200 MHz signal.
- d. Set the Spectrum Analyzer GAIN control so that the 200 MHz signal is exactly 6 centimeters.
- e. Switch the 1 dB IF ATTEN switch On (up) and adjust the Attenuator control of the generator so that the 200 MHz display is exactly 6 centimeters high. The generator Attenuator control should read -69 dBm ± 0.1 dBm.
- f. Switch the 1 dB IF ATTEN switch to OFF.
- g. Check the rest of the IF ATTEN steps as directed in Table 6-3.

TABLE 6-3

Spectrum Analyzer IF ATTEN switch ON	RF Generator Attenuator Control Setting
2 dB	-68 dBm $\pm .2$ dBm
4 dB	-66 dBm $\pm .4$ dBm
8 dB	-62 dBm $\pm .8$ dBm
16 dB	-54 dBm ± 1.6 dBm
20 dB	-50 dBm ± 2.0 dBm

NOTES

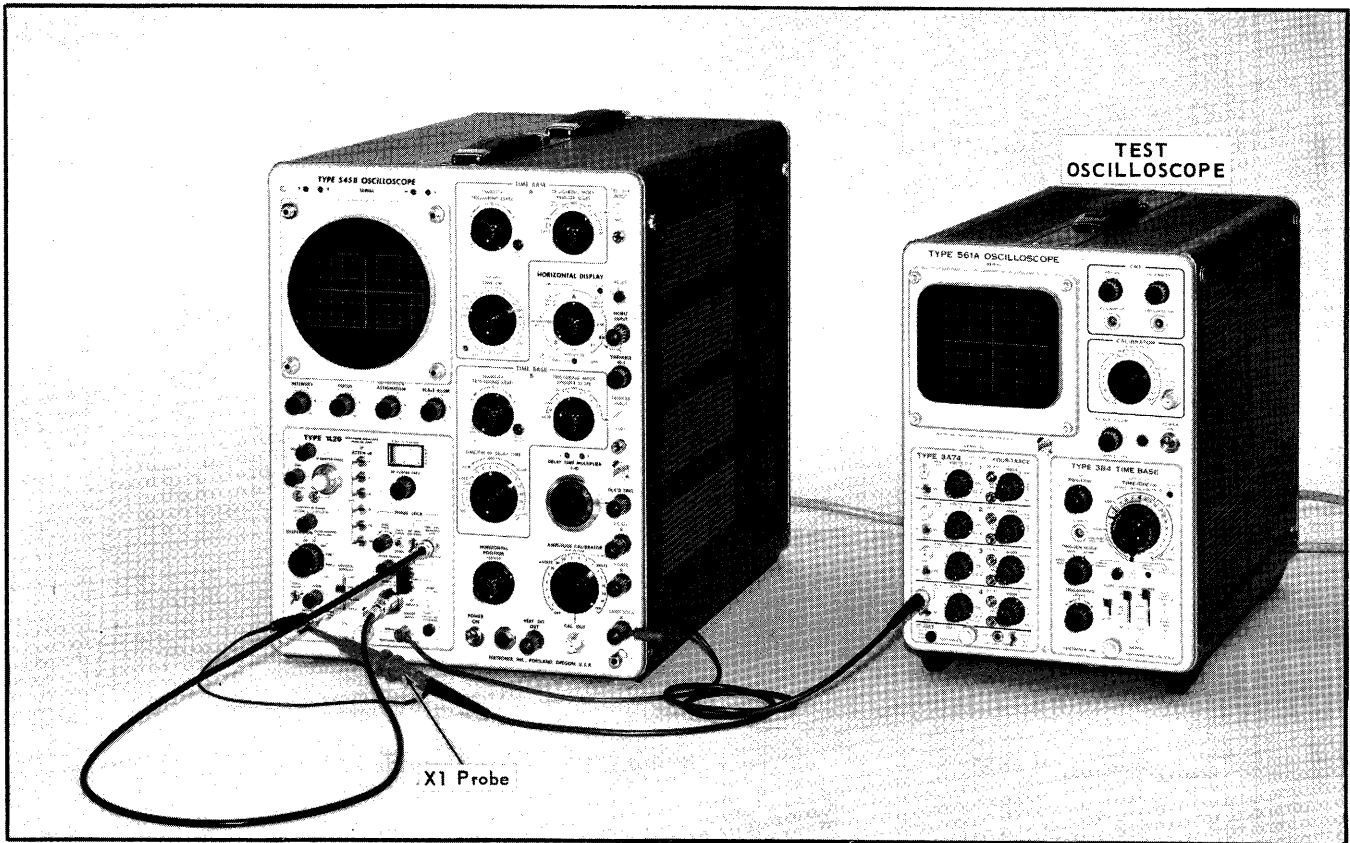

Fig. 6-23. Setup for checking TO RECORDER Output (Step 17).

17. Check TO RECORDER Output

- a. Connect the equipment as shown in Fig. 6-23.
- b. Preset the controls of the Spectrum Analyzer as follows:

POS	Position the trace to the bottom line of the graticule
DISPERSION RANGE	MHz/CM
DISPERSION—COUPLED RESOLUTION	1 (Outer Ring)
VERTICAL DISPLAY	LIN
INT 1 MHz REF FREQ	Up

- c. Adjust the GAIN control for a 6 centimeter display.
- d. Measure the TO RECORDER signal with the test oscilloscope. Check for 12 millivolts to 20 millivolts.

18. Check VIDEO FILTER

- a. Connect the 1 MHz CAL MARKERS OUT signal to the RF INPUT connector.
- b. Set the controls of the Analyzer as directed in Steps 17b and 17c above.

- c. Switch on the VIDEO FILTER and check for an attenuated display resembling a sawtooth (see Fig. 6-24).
- d. Change the sweep rate to 1 SEC/CM. The display should not change appreciably when the VIDEO FILTER is switched in and out.

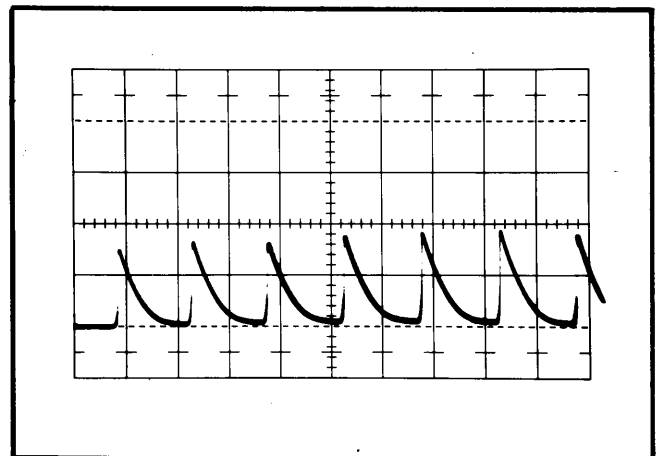

Fig. 6-24. 1 MHz marker display with VIDEO FILTER switched to ON. (Step 18).

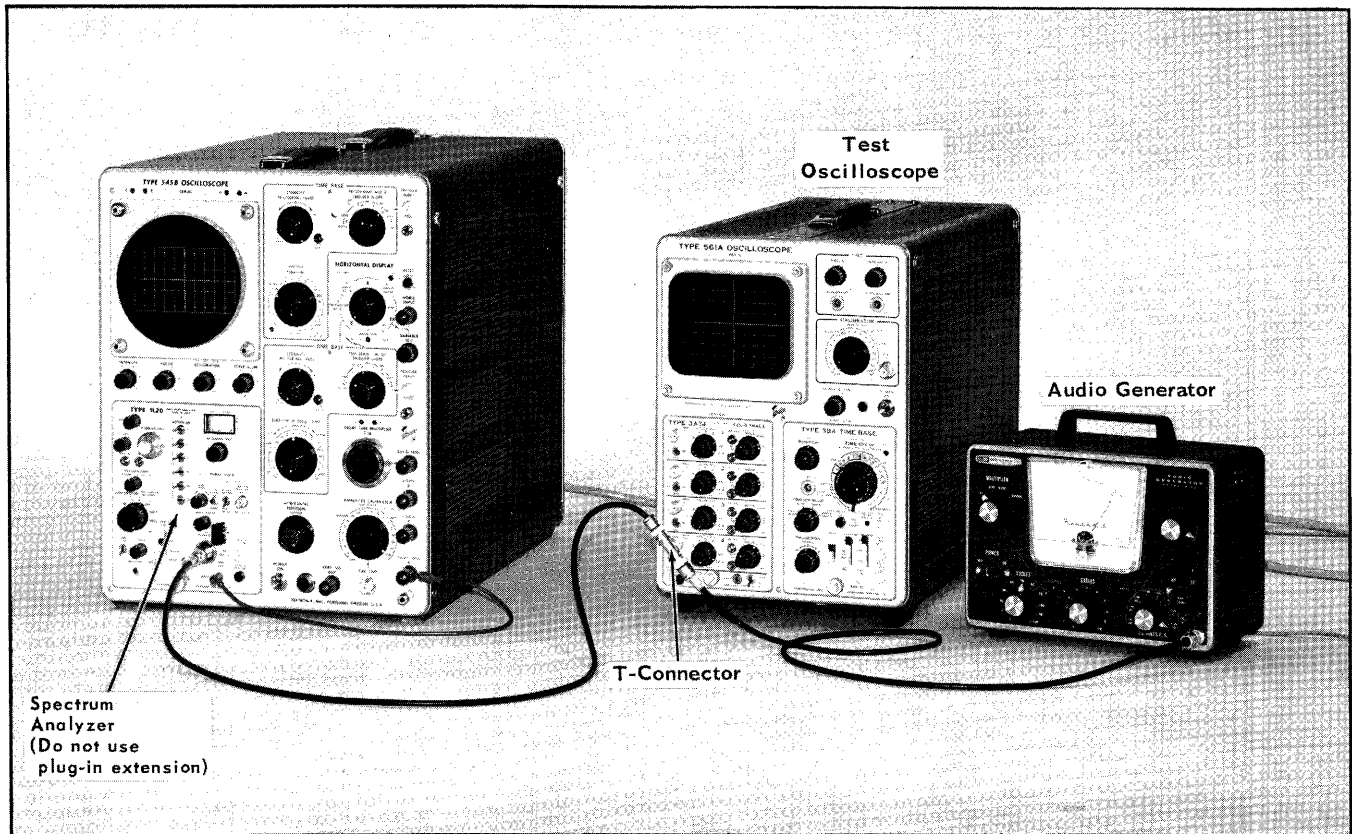

Fig. 6-25. Setup for checking VIDEO INPUT.

19. Check Frequency Response of VIDEO INPUT Circuit

- a. Connect the equipment as shown in Fig. 6-27.
- b. Preset the controls of the Spectrum Analyzer as follows:

POS	Position the trace to the center line of the graticule
GAIN	Fully clockwise
VERTICAL DISPLAY	VIDEO
- c. Apply a 50 kHz signal from the audio generator to the VIDEO INPUT connector of the Analyzer. Adjust the Output control of the generator to obtain 4 centimeters of deflection.

d. Monitor the signal amplitude with a DC coupled test oscilloscope for constant amplitude, and decrease the output frequency of the generator.

e. The frequency at which the Analyzer display falls to 2.8 centimeters should be ≤ 16 Hz.

f. Apply a 50 kHz signal from the Constant Amplitude RF Generator to the VIDEO INPUT connector of the Analyzer. Adjust the signal amplitude for 4 centimeters of deflection.

g. Increase the signal frequency until the amplitude of the Analyzer display falls to 2.8 centimeters. At this point the output frequency should be ≥ 10 MHz.

NOTES

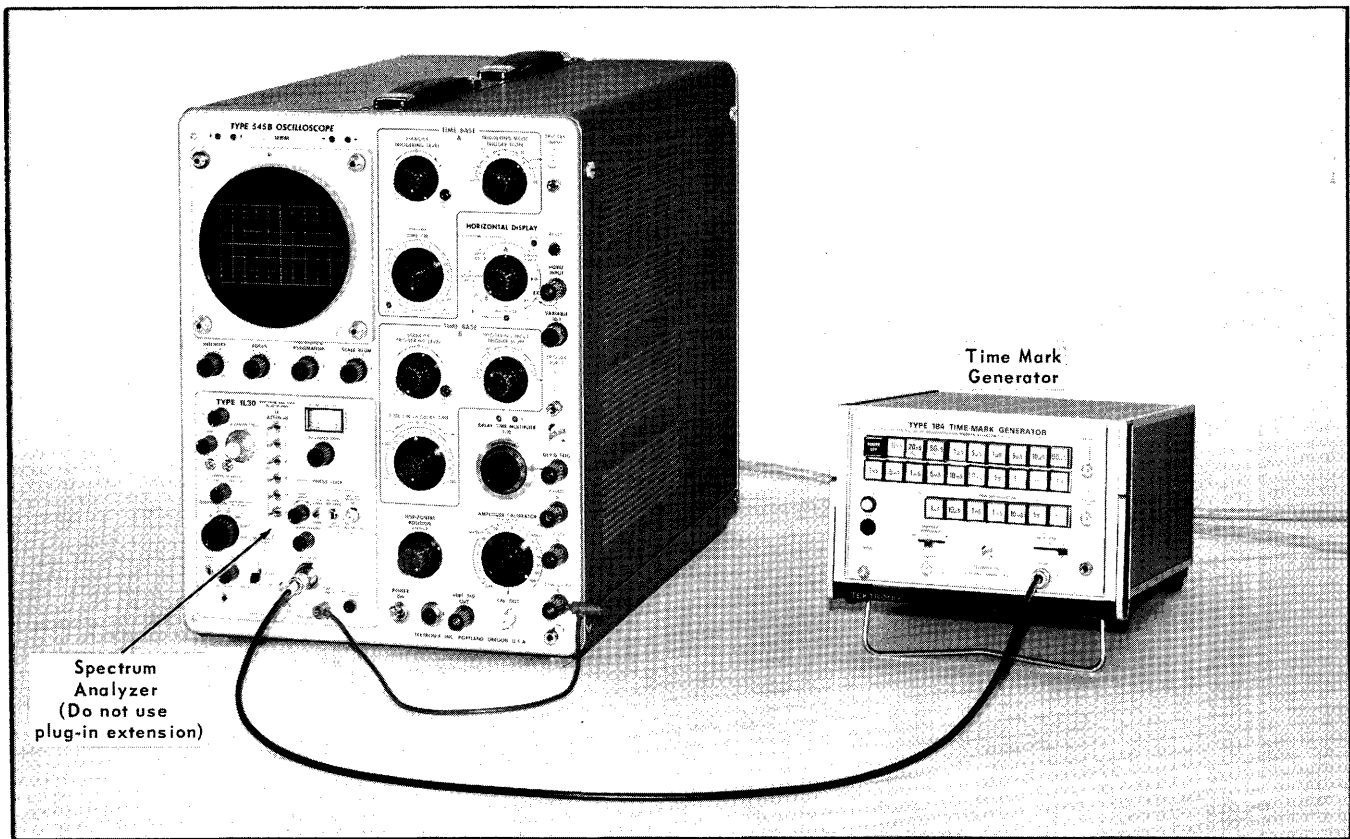

Fig. 6-26. Setup for checking Incidental Frequency Modulation.

20. Check Incidental Frequency Modulation

a. Set up the equipment as shown in Fig. 6-26.

b. Preset the controls as follows:

DISPERSION RANGE	kHz/CM
DISPERSION	500
IF ATTEN	All OFF
VERTICAL DISPLAY	LIN
INT 1 MHz REF FREQ	OFF

c. Apply a 200 MHz signal from the Time-Mark Generator and center the IF feedthrough signal on the CRT.

d. Change the DISPERSION—COUPLED RESOLUTION switch to 1, adjusting the IF CENTER FREQ controls as needed to keep the signal centered on the screen.

e. Adjust the GAIN control for six centimeters of deflection.

f. Adjust the POS control for a display similar to Fig. 6-27.

g. Set the oscilloscope sweep rate to 20 mS/CM. The display must not show more than 1 minor division of frequency modulation.

h. Move the IF feedthrough signal off the screen with the IF CENTER FREQ control and center the tunable signal on the CRT with the RF CENTER FREQ control. The display must not show more than 0.8 centimeters of frequency modulation.

i. Turn the INT 1 MHz REF FREQ switch to On (Up) and phase lock the display. (See page 2-5.) The display must not show more than 0.3 centimeters of frequency modulation.

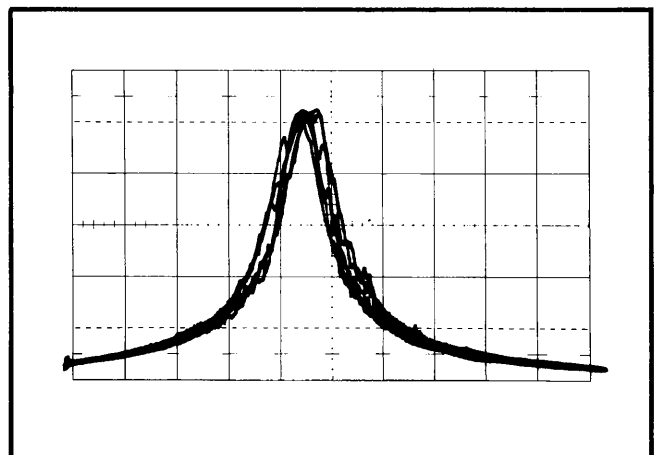

Fig. 6-27. Typical display for checking Incidental Frequency Modulation.

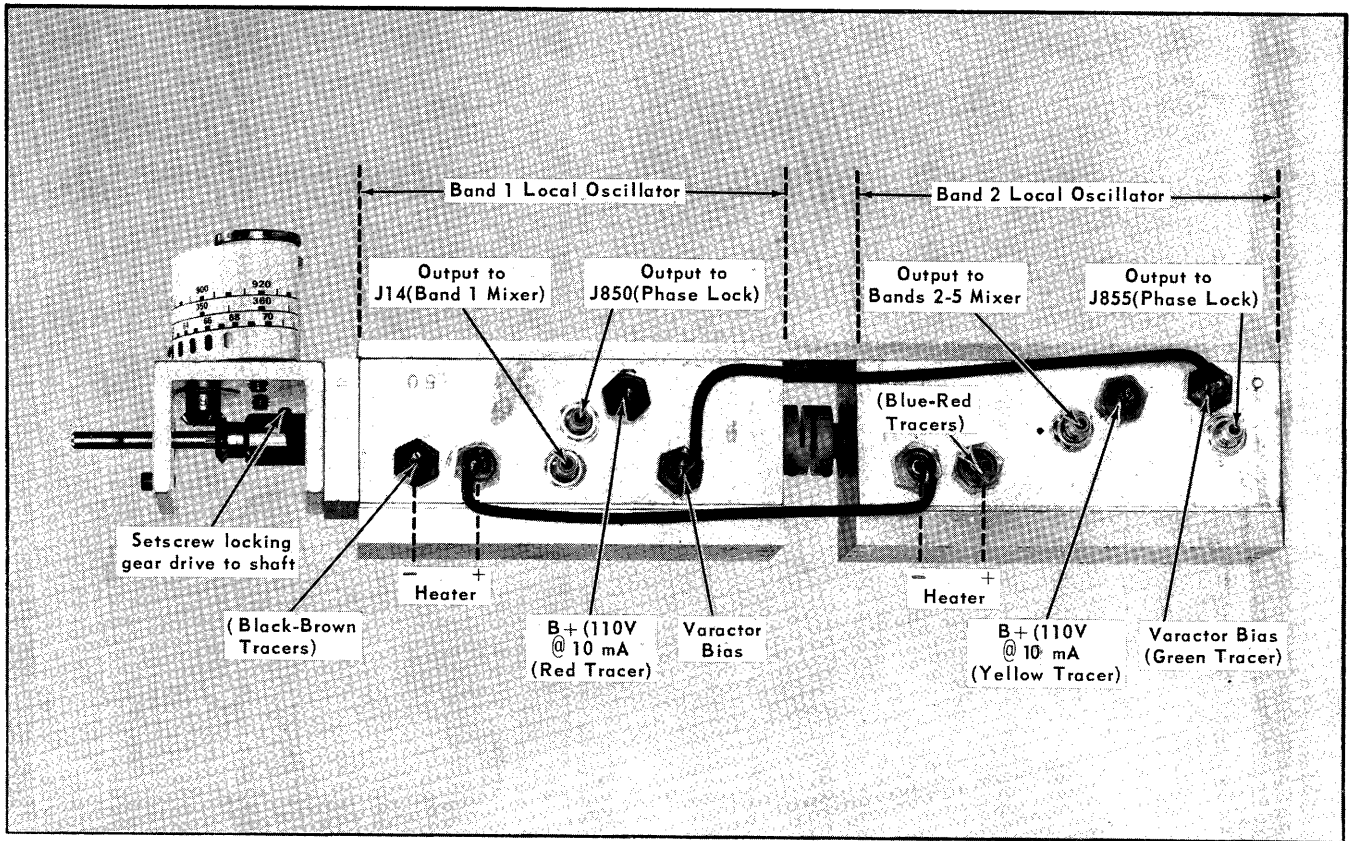

Fig. 6-28. Local Oscillator connections.

DIAL TRACKING PROCEDURE

NOTE

The procedures which follow are NOT part of the routine calibration of the Type 1L20, and should be done ONLY after parts replacement or repair of the application oscillators. See NOTE on Page 6-1.

1. Install the dial tape on the sprocket assembly. Adjust the position of the tape for about the same amount of travel beyond the printing at each end.
2. Connect the power to the oscillator (see Fig. 6-27). Set the varactor bias to +7.0 volts.
3. Use an accurate frequency meter to tune the Band 1 oscillator to exactly 375.5 MHz.
4. Position the dial tape to read 175.5 on Band 1. The sprocket drive will probably prevent exact positioning of the dial tape; if this is the case, loosen the set screws locking the gear to the oscillator shaft (See Fig. 6-27) and disengage the tape drive to reset the tape.
5. Check the dial tape tracking at several points, including each end of the dial tape. The oscillator frequency is always 200 MHz above the dial tape reading. The oscillator frequency must be within $\pm 1\%$ of the dial tape frequency +200 MHz.
6. Tune the Bands 2-5 oscillator to exactly 835 MHz. The dial tape should read 635 ± 8 on Band 2. If the tape does

not read within this range, then the coupling between the two oscillators must be reset as follows:

- a. Loosen the two screws holding the flexible coupling to the Band 1 (front) oscillator.
 - b. Set the tape to read exactly 635.
 - c. While holding the front shaft at 635 on the dial tape, tune the Band 2-5 (rear) oscillator to 835 MHz.
 - d. Tighten the set screws.
7. Check the dial tape tracking on Band 2 at several points, including each end of the band. The oscillator frequency must always be within $\pm 1\%$ of the dial frequency +200 MHz.

BAND 1 LOCAL OSCILLATOR CALIBRATION PROCEDURE

NOTE

This procedure is to be used only after replacing V40 (the Band 1 Local Oscillator tube) or performing some other internal repair on the Band 1 Local Oscillator. This procedure requires that the Bands 2-5 Local Oscillator be operating and tracking to the dial tape.

1. Remove the complete oscillator and dial tape assembly from the Type 1L20. **Do not** uncouple the tuning shaft between the two oscillator units.

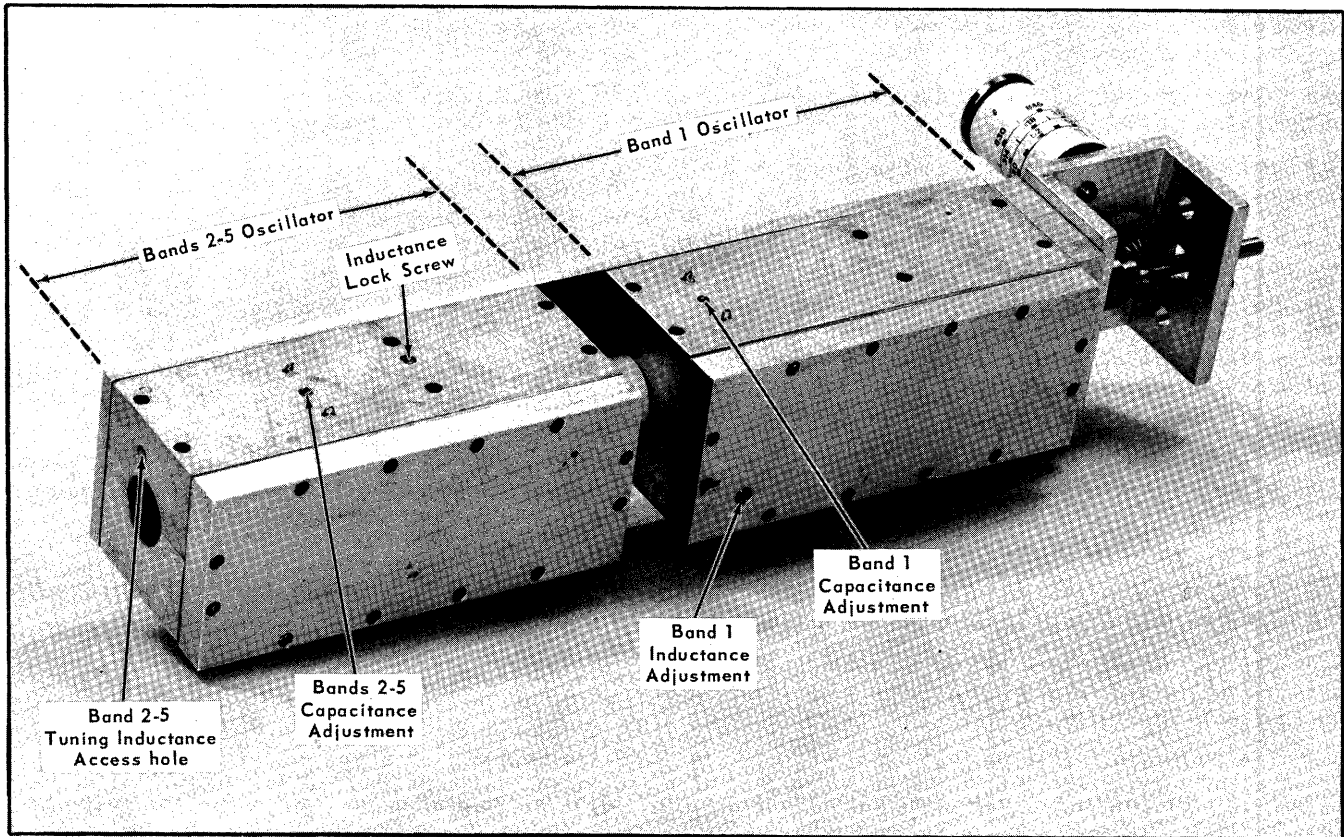

Fig. 6-29. Local Oscillator adjustments.

2. Perform the necessary repairs. Replace all covers; all screws must be tight. The dial tape must be attached and coupled to the oscillator tuning shaft.

3. Connect the necessary power connections to the Band 2 (rear) Local Oscillator (see Fig. 6-27).

4. Set the Type 1L20 FINE FREQ control for +7.0 volts at the varactor bias terminal.

5. Using an accurate frequency meter, set the Band 2 Local Oscillator to 835 MHz.

6. Check that the dial tape reads exactly 635 on Band 2. If it does not, loosen the set screws holding the gear drive on the tuning shaft and move the dial tape as required. This sets the dial tape to a known point on the tuning curve for both oscillators.

7. Check the dial tape tracking of Band 2 at several points, including each end of the band. The oscillator frequency must be within $\pm 1\%$ of the dial tape frequency +200 MHz.

8. Connect the power to the Band 1 (front) Local Oscillator (see Fig. 6-27).

9. Check for +7.0 volts at the varactor bias terminal.

10. Set the frequency meter to indicate 210 MHz. Set the dial tape to 10 and adjust the Band 1 inductance adjustment (see Fig. 6-30) to tune the oscillator frequency to 210 MHz.

11. Set the frequency meter to indicate 475 MHz. Set the dial tape to 275 and adjust the Band 1 capacitance adjust-

ment (see Fig. 6-30) to tune the oscillator frequency to 475 MHz.

12. Repeat steps 10 and 11 until both frequency points match the dial tape.

13. Set the frequency meter to indicate 375.5 MHz. Tune the oscillator to 375.5 MHz. The dial tape must read between 174 and 177.

14. If the tape does not read within this range, then both oscillators require recalibration at the factory using special test equipment.

BANDS 2-5 LOCAL OSCILLATOR CALIBRATION PROCEDURE

NOTE

This procedure is to be used only after replacing V41 (the Bands 2-5 Local Oscillator tube) or performing some other internal repair on the Bands 2-5 Local Oscillator. This procedure requires that the Band 1 Local Oscillator be operating and tracking to the dial tape.

1. Remove the entire oscillator and dial tape assembly from the Type 1L20. **Do not** uncouple the tuning shaft between the two oscillator units.

ABBREVIATIONS AND SYMBOLS

A or amp	amperes	λ	lambda—wavelength
AC or ac	alternating current	$<$	less than
AF	audio frequency	LF	low frequency
α	alpha—common-base current amplification factor	lg	length or long
AM	amplitude modulation	LV	low voltage
\approx	approximately equal to	M	mega or 10^6
β	beta—common-emitter current amplification factor	m	milli or 10^{-3}
BHB	binding head brass	M Ω or meg	megohm
BHS	binding head steel	μ	micro or 10^{-6}
BNC	baby series "N" connector	mc	megacycle
X	by or times	met.	metal
C	carbon	mm	millimeter
C	capacitance	ms	millisecond
cap.	capacitor	—	minus
cer	ceramic	mtg hdw	mounting hardware
cm	centimeter	n	nano or 10^{-9}
comp	composition	no. or #	number
conn	connector	ns	nanosecond
\sim	cycle	OD	outside diameter
c/s or cps	cycles per second	OHB	oval head brass
CRT	cathode-ray tube	OHS	oval head steel
csk	countersunk	Ω	ohms
		ω	omega—angular frequency
dB	decibel	p	pico or 10^{-12}
dBm	decibel referred to one milliwatt	/	per
DC or dc	direct current	%	percent
DE	double end	PHB	pan head brass
$^\circ$	degrees	ϕ	phi—phase angle
$^\circ\text{C}$	degrees Celsius (degrees centigrade)	π	pi—3.1416
$^\circ\text{F}$	degrees Fahrenheit	PHS	pan head steel
$^\circ\text{K}$	degrees Kelvin	+	plus
dia	diameter	\pm	plus or minus
\div	divide by	PIV	peak inverse voltage
div	division	plstc	plastic
EHF	extremely high frequency	PMC	paper, metal cased
EMC	electrolytic, metal cased	poly	polystyrene
EMT	electrolytic, metal tubular	prec	precision
ϵ	epsilon—2.71828 or % of error	PT	paper, tubular
\geq	equal to or greater than	PTM	paper or plastic, tubular, molded
\leq	equal to or less than	pwr	power
ext	external	RC	resistance capacitance
F or f	farad	RF	radio frequency
F & I	focus and intensity	RFI	radio frequency interference
FHB	flat head brass	RHB	round head brass
FHS	flat head steel	ρ	rho—resistivity
Fil HB	fillister head brass	RHS	round head steel
Fil HS	fillister head steel	r/min or rpm	revolutions per minute
FM	frequency modulation	RMS	root mean square
ft	feet or foot	s or sec.	second
G	giga or 10^9	SE	single end
g	acceleration due to gravity	Si	silicon
Ge	germanium	SN or S/N	serial number
GMV	guaranteed minimum value	T	tera or 10^{12}
GR	General Radio	TC	temperature compensated
$>$	greater than	TD	tunnel diode
H or h	henry	THB	truss head brass
h	height or high	θ	theta—angular phase displacement
hex.	hexagonal	thk	thick
HF	high frequency	THS	truss head steel
HHB	hex head brass	tub.	tubular
HHS	hex head steel	UHF	ultra high frequency
HSB	hex socket brass	V	volt
HSS	hex socket steel	VAC	volts, alternating current
HV	high voltage	var	variable
Hz	hertz (cycles per second)	VDC	volts, direct current
ID	inside diameter	VHF	very high frequency
IF	intermediate frequency	VSWR	voltage standing wave ratio
in.	inch or inches	W	watt
incd	incandescent	w	wide or width
∞	infinity	w/	with
int	internal	w/o	without
\int	integral	WW	wire-wound
k	kilohms or kilo (10^3)	xmfr	transformer
k Ω	kilohm		
kc	kilocycle		

PARTS ORDERING INFORMATION

Replacement parts are available from or through your local Tektronix, Inc. Field Office or representative.

Changes to Tektronix instruments are sometimes made to accommodate improved components as they become available, and to give you the benefit of the latest circuit improvements developed in our engineering department. It is therefore important, when ordering parts, to include the following information in your order: Part number, instrument type or number, serial or model number, and modification number if applicable.

If a part you have ordered has been replaced with a new or improved part, your local Tektronix, Inc. Field Office or representative will contact you concerning any change in part number.

SPECIAL NOTES AND SYMBOLS

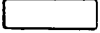
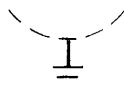
- ×000 Part first added at this serial number
- 00× Part removed after this serial number
- *000-0000-00 Asterisk preceding Tektronix Part Number indicates manufactured by or for Tektronix, Inc., or reworked or checked components.
- Use 000-0000-00 Part number indicated is direct replacement.
-  Screwdriver adjustment.
-  Control, adjustment or connector.
-  Heat sink.

SECTION 7

ELECTRICAL PARTS LIST

Values are fixed unless marked Variable.

Ckt. No.	Tektronix Part No.	Description			S/N Range
Capacitors					
Tolerance $\pm 20\%$ unless otherwise indicated.					
C10	283-0067-00	0.0001 μ F	Cer		200 V 10%
C14	281-0105-00	0.8-8.5 pF	Cer	Var	
C16	281-0105-00	0.8-8.5 pF	Cer	Var	
C17	281-0518-00	47 pF	Cer		500 V
C23	281-0613-00	10 pF	Cer		200 V 10%
C24	281-0105-00	0.8-8.5 pF	Cer	Var	
C26	281-0613-00	10 pF	Cer		200 V 10%
C27	281-0105-00	0.8-8.5 pF	Cer	Var	
C29	281-0613-00	10 pF	Cer		200 V 10%
C30	281-0105-00	0.8-8.5 pF	Cer	Var	
C32	281-0613-00	10 pF	Cer		200 V 10%
C34	281-0105-00	0.8-8.5 pF	Cer	Var	
C83	281-0616-00	6.8 pF	Cer		200 V
C84	281-0105-00	0.8-8.5 pF	Cer	Var	
C86	281-0616-00	6.8 pF	Cer		200 V
C87	281-0105-00	0.8-8.5 pF	Cer	Var	
C89	281-0616-00	6.8 pF	Cer		200 V
C90	281-0105-00	0.8-8.5 pF	Cer	Var	
C92	281-0616-00	6.8 pF	Cer		200 V
C94	281-0105-00	0.8-8.5 pF	Cer	Var	
C101	281-0101-00	1.5-9.1 pF	Air	Var	
C102	281-0099-00	1.3-5.4 pF	Air	Var	
C104	281-0101-00	1.5-9.1 pF	Air	Var	
C105	281-0648-00	56 pF	Cer		5%
C106	281-0101-00	1.5-9.1 pF	Air	Var	
C107	281-0099-00	1.3-5.4 pF	Air	Var	
C108	281-0101-00	1.5-9.1 pF	Air	Var	
C123	281-0635-00	1000 pF	Cer		500 V
C124	281-0523-00	100 pF	Cer		350 V
C128	283-0065-00	0.001 μ F	Cer		100 V 5%
C130	283-0103-00	180 pF	Cer		500 V 5%
C132	283-0039-00	0.001 μ F	Cer		500 V
C133	281-0635-00	1000 pF	Cer		500 V
C137	281-0063-00	9-35 pF	Cer	Var	
C138	281-0635-00	1000 pF	Cer		500 V

Electrical Parts List—Type 1L20

Capacitors (Cont)

Ckt. No.	Tektronix Part No.		Description		S/N Range
C139	283-0039-00	0.001 μ F	Cer	500 V	
C140	283-0103-00	180 pF	Cer	500 V	5%
C143	281-0635-00	1000 pF	Cer	500 V	
C145	281-0558-00	18 pF	Cer	500 V	
C146	281-0549-00	68 pF	Cer	500 V	10%
C147	281-0523-00	100 pF	Cer	350 V	
C148	283-0065-00	0.001 pF	Cer	100 V	5%
C149	281-0635-00	1000 pF	Cer	500 V	
C151	281-0549-00	68 pF	Cer	500 V	10%
C152	281-0549-00	68 pF	Cer	500 V	10%
C187	281-0549-00	68 pF	Cer	500 V	10%
C188	281-0549-00	68 pF	Cer	500 V	10%
C231	285-0519-00	0.047 μ F	Cer	400 V	
C245	283-0065-00	0.001 μ F	Cer	100 V	5%
C246	283-0003-00	0.01 μ F	Cer	150 V	
C248	285-0703-00	0.1 μ F	PTM	100 V	5%
C255	283-0001-00	0.005 μ F	Cer	500 V	
C274	281-0605-00	200 pF	Cer	500 V	
C293	283-0010-00	0.05 μ F	Cer	50 V	
C300	283-0039-00	0.001 μ F	Cer	500 V	
C310	283-0065-00	0.001 μ F	Cer	100 V	5%
C311	281-0613-00	10 pF	Cer	200 V	10%
C314	283-0563-00	1000 pF	Mica	500 V	10%
C315	281-0610-00	2.2 pF	Cer	200 V	
C320	283-0039-00	0.001 μ F	Cer	500 V	
C330	283-0003-00	0.01 μ F	Cer	150 V	
C331	283-0003-00	0.01 μ F	Cer	150 V	
C346	283-0050-00	0.008 μ F	Cer	200 V	
C347	283-0050-00	0.008 μ F	Cer	200 V	
C349	281-0503-00	8 pF	Cer	500 V	± 0.5 pF
C357	283-0050-00	0.008 μ F	Cer	200 V	
C358	281-0105-00	0.8-8.5 pF	Cer	Var	
C361	283-0039-00	0.001 μ F	Cer	500 V	
C362	281-0635-00	1000 pF	Cer	500 V	
C363	283-0039-00	0.001 μ F	Cer	500 V	
C365	283-0025-00	0.0005 μ F	Cer	500 V	5%
C367	283-0039-00	0.001 μ F	Cer	500 V	
C368	283-0003-00	0.01 μ F	Cer	150 V	
C373	283-0039-00	0.001 μ F	Cer	500 V	
C376	283-0039-00	0.001 μ F	Cer	500 V	
C383	283-0039-00	0.001 μ F	Cer	500 V	
C384	281-0105-00	0.8-8.5 pF	Cer	Var	
C385	281-0105-00	0.8-8.5 pF	Cer	Var	
C386	283-0039-00	0.001 μ F	Cer	500 V	
C401	283-0065-00	0.001 μ F	Cer	100 V	5%
C412	283-0003-00	0.01 μ F	Cer	150 V	

Capacitors (Cont)

Ckt. No.	Tektronix Part No.		Description			S/N Range
C413	283-0039-00	0.001 μ F	Cer		500 V	
C416	283-0001-00	0.005 μ F	Cer		500 V	
C422	281-0599-00	1 pF	Cer		200 V	± 0.25 pF
C423	283-0065-00	0.001 μ F	Cer		100 V	5%
C424	281-0564-00	24 pF	Cer		500 V	5%
C425	281-0105-00	0.8-8.5 pF	Cer	Var		
C426	283-0065-00	0.001 μ F	Cer		100 V	5%
C427	283-0065-00	0.001 μ F	Cer		100 V	5%
C433	283-0065-00	0.001 μ F	Cer		100 V	5%
C434	281-0645-00	8.2 pF	Cer		500 V	± 0.25 pF
C435	281-0105-00	0.8-8.5 pF	Cer	Var		
C436	283-0065-00	0.001 μ F	Cer		100 V	5%
C437	283-0001-00	0.005 μ F	Cer		500 V	
C443	283-0001-00	0.005 μ F	Cer		500 V	
C445	281-0564-00	24 pF	Cer		500 V	5%
C446	281-0579-00	21 pF	Cer		500 V	5%
C447	281-0550-00	120 pF	Cer		500 V	10%
C450	281-0511-00	22 pF	Cer		500 V	10%
C453	283-0001-00	0.005 μ F	Cer		500 V	
C454	283-0566-00	100 pF	Mica		500 V	5%
C456	283-0001-00	0.005 μ F	Cer		500 V	
C457	283-0001-00	0.005 μ F	Cer		500 V	
C462	283-0039-00	0.001 μ F	Cer		500 V	
C463	283-0001-00	0.005 μ F	Cer		500 V	
C464	283-0566-00	100 pF	Mica		500 V	5%
C466	283-0001-00	0.005 μ F	Cer		500 V	
C467	283-0001-00	0.005 μ F	Cer		500 V	
C469	283-0039-00	0.001 μ F	Cer		500 V	
C501	281-0523-00	100 pF	Cer		350 V	
C502	281-0523-00	100 pF	Cer		350 V	
C504	281-0105-00	0.8-8.5 pF	Cer	Var		
C508	281-0105-00	0.8-8.5 pF	Cer	Var		
C515	283-0065-00	0.001 μ F	Cer		100 V	5%
C524	283-0039-00	0.001 μ F	Cer		500 V	
C525	283-0039-00	0.001 μ F	Cer		500 V	
C527	283-0003-00	0.01 μ F	Cer		150 V	
C530	283-0003-00	0.01 μ F	Cer		150 V	
C534	283-0003-00	0.01 μ F	Cer		150 V	
C537	283-0003-00	0.01 μ F	Cer		150 V	
C539	283-0003-00	0.01 μ F	Cer		150 V	
C610	281-0099-00	1.3-5.4 pF	Air	Var		
C620	281-0105-00	0.8-8.5 pF	Cer	Var		
C623	283-0003-00	0.01 μ F	Cer		150 V	
C626	283-0003-00	0.01 μ F	Cer		150 V	
C651	283-0001-00	0.005 μ F	Cer		500 V	

Electrical Parts List—Type 1L20

Capacitors (Cont)

Ckt. No.	Tektronix Part No.		Description		S/N Range
C656	283-0001-00	0.005 μ F	Cer	500 V	
C658	283-0083-00	0.0047 μ F	Cer	500 V	5%
C660	281-0629-00	33 pF	Cer	600 V	5%
C661	283-0081-00	0.1 μ F	Cer	25 V	+80%—20%
C662	283-0001-00	0.005 μ F	Cer	500 V	
C668	285-0703-00	0.1 μ F	PTM	100 V	5%
C801	283-0065-00	0.001 μ F	Cer	100 V	5%
C806	281-0543-00	270 pF	Cer	500 V	10%
C807	281-0536-00	1000 pF	Cer	500 V	10%
C810	283-0003-00	0.01 μ F	Cer	150 V	
C823	283-0081-00	0.1 μ F	Cer	25 V	+80%—20%
C832	283-0065-00	0.001 μ F	Cer	100 V	5%
C844	283-0127-00	2.5 pF	Cer	100 V	
C846	283-0127-00	2.5 pF	Cer	100 V	
C847	283-0127-00	2.5 pF	Cer	100 V	
C851	283-0127-00	2.5 pF	Cer	100 V	
C852	283-0127-00	2.5 pF	Cer	100 V	
C854	283-0065-00	0.001 μ F	Cer	100 V	5%
C856	283-0127-00	2.5 pF	Cer	100 V	
C857	283-0127-00	2.5 pF	Cer	100 V	
C859	283-0065-00	0.001 μ F	Cer	100 V	5%
C876	283-0059-00	1 μ F	Cer	25 V	+80%—20%
C883	283-0065-00	0.001 μ F	Cer	100 V	5%
C890	283-0081-00	0.1 μ F	Cer	25 V	+80%—20%
C892	283-0092-00	0.03 μ F	Cer	200 V	+80%—20%
C894	283-0079-00	0.01 μ F	Cer	250 V	

Diodes

D14 } D16 } D64 } D240 } D244 }	*153-0024-00	Germanium 1N82A (matched pair)
	152-0194-00	Silicon 1N416D
	152-0166-00	Zener 1N753A 0.4 W, 6.2 V, 10%
	*152-0061-00	Silicon Tek Spec
D314 } D334 } D361 } D362 } D365 }	152-0231-00	Silicon MV1872
	*152-0107-00	Silicon Replaceable by 1N647
	*152-0153-00	Silicon Replaceable by 1N4244
	*152-0185-00	Silicon Replaceable by 1N3605
	*152-0153-00	Silicon Replaceable by 1N4244
D373 } D376 } D380 } D383 } D386 }	*152-0025-00	Silicon Selected *152-0153-00 (1 pair)
	152-0238-00	Silicon 1N4442
	*152-0025-00	Silicon Selected *152-0153-00 (1 pair)
D387 } D412 } D454 } D506 } D550 }	152-0238-00	Silicon 1N4442
	*152-0107-00	Silicon Replaceable by 1N647
	152-0141-00	Silicon 1N3605
	152-0141-00	Silicon 1N3605
	*152-0107-00	Silicon Replaceable by 1N647

Diodes (Cont)

Ckt. No.	Tektronix Part No.	Description	S/N Range
D603	152-0188-00	Germanium 1N64	
D604	152-0188-00	Germanium 1N64	
D657	152-0186-00	Germanium 1N198	
D660	152-0186-00	Germanium 1N198	
D661	152-0186-00	Germanium 1N198	
D664	152-0141-00	Silicon 1N3605	
D665	152-0141-00	Silicon 1N3605	
D812	*152-0185-00	Silicon Replaceable by 1N3605	
D821	*152-0185-00	Silicon Replaceable by 1N3605	
D841	152-0079-00	Germanium HD1841	
D846	*152-0112-00	Snap Off	
D851	*152-0152-00	GaAs (1 pair)	
D852			
D856			
D857	*152-0152-00	GaAs (1 pair)	

Connectors

J1	131-0390-00	BNC, panel mtd., female
J10	131-0372-00	Coaxial
J14	131-0372-00	Coaxial
J18	131-0372-00	Coaxial
J20	131-0372-00	Coaxial
J34	131-0372-00	Coaxial
J65	*103-0057-00	Adapter
J71 ¹		
J73 ¹		
J75 ¹		
J80	131-0372-00	Coaxial
J94	131-0372-00	Coaxial
J100	131-0372-00	Coaxial
J109	131-0372-00	Coaxial
J120	131-0372-00	Coaxial
J147	131-0372-00	Coaxial
J148	131-0372-00	Coaxial
J151	131-0372-00	Coaxial
J188	131-0372-00	Coaxial
J201	131-0106-00	Chassis mtd., 1 contact, female
J363	131-0372-00	Coaxial
J370	131-0372-00	Coaxial
J373	131-0372-00	Coaxial
J376	131-0372-00	Coaxial

¹Furnished as a unit with SW40 and SW70.

Electrical Parts List—Type 1L20

Connectors (Cont)

Ckt. No.	Tektronix Part No.	Description	S/N Range
J379	131-0372-00	Coaxial	
J401	131-0372-00	Coaxial	
J470	131-0372-00	Coaxial	
J501	131-0372-00	Coaxial	
J658	136-0094-00	Socket w/hardware	
J669	131-0106-00	Chassis mtd., 1 contact, female	
J720	136-0140-00	Socket, Banana Jack Assembly	
J810	131-0429-00	BNC	
J850	131-0372-00	Coaxial	
J855	131-0372-00	Coaxial	

Inductors

L10	*108-0220-00	0.15 μ H		
L21	*108-0388-00	35 nH		
L23	*108-0385-00	8 nH		
L24	*108-0390-00	45 nH		
L26	*108-0387-00	24 nH		
L27	*108-0389-00	40 nH		
L29	*108-0386-00	15 nH		
L30	*180-0389-00	40 nH		
L66	*180-0394-00	30 nH		
L81	*180-0380-00	32 nH		
L83	*180-0377-00	7 nH		
L84	*180-0382-00	41 nH		
L86	*108-0379-00	22 nH		
L87	*108-0381-00	36 nH		
L89	*108-0378-00	14 nH		
L90	*108-0381-00	36 nH		
L101	*108-0371-00	0.23 μ H		
L102	*108-0370-00	0.14 μ H		
L104	*108-0369-00	0.12 μ H		
L105	*108-0401-00	14 nH		
L106	*108-0369-00	0.12 μ H		
L107	*108-0370-00	0.14 μ H		
L108	*108-0371-00	0.23 μ H		
L124	*108-0373-00	56 nH		
L134	*114-0205-00	54-66 nH	Var	Core 276-0506-00
L144	*114-0206-00	234-286 nH	Var	Core 276-0506-00
L147	*114-0205-00	54-66 nH	Var	Core 276-0506-00
L151	*108-0310-00	0.09 μ H		
L188	*108-0310-00	0.09 μ H		
L313	*108-0215-00	1.1 μ H		

Inductors (Cont)

Ckt. No.	Tektronix Part No.	Description	S/N Range	
L314 ²				
L320	*108-0215-00	1.1 μ H		
L325	276-0507-00	Core, Ferramic Suppressor		
L333	*108-0215-00	1.1 μ H		
L343	*108-0215-00	1.1 μ H		
L348	*108-0304-00	45 nH		
L358	*108-0372-00	27 nH		
L384	*108-0374-00	55 nH		
L385	*108-0374-00	55 nH		
L444	*114-0207-00	180-220 nH	Var	Core 276-0506-00
L446	*108-0215-00	1.1 μ H		
L456	276-0507-00	Core, Ferramic Suppressor		
L508	108-0363-00	67 μ H		
L534	108-0226-00	100 μ H		
L620	108-0366-00	67 μ H		
L624	114-0209-00	28-60 μ H	Var	Core 276-0506-00
L675	276-0507-00	Core, Ferramic Suppressor		
L676	276-0507-00	Core, Ferramic Suppressor		
L804	*114-0208-00	70-120 μ H	Var	Core 276-0506-00
LR413	*108-0368-00	10 μ H (wound on a 1 k Ω resistor)		
LR423	*108-0367-00	1 μ H (wound on a 1 k Ω resistor)		
LR427	*108-0367-00	1 μ H (wound on a 1 k Ω resistor)		
LR433	*108-0367-00	1 μ H (wound on a 1 k Ω resistor)		
LR437	*108-0368-00	10 μ H (wound on a 1 k Ω resistor)		
LR443	*108-0368-00	10 μ H (wound on a 1 k Ω resistor)		
LR453	*108-0368-00	10 μ H (wound on a 1 k Ω resistor)		
LR457	*108-0368-00	10 μ H (wound on a 1 k Ω resistor)		
LR463	*108-0368-00	10 μ H (wound on a 1 k Ω resistor)		
LR467	*108-0368-00	10 μ H (wound on a 1 k Ω resistor)		
Plug				
P11	131-0017-00	Chassis, mtd., 16 contact, male		
Transistors				
Q120	151-0180-00	Silicon 40235 (RCA)		
Q130	151-0180-00	Silicon 40235 (RCA)		
Q140	151-0181-00	Silicon 40242 (RCA)		
Q230	*151-0155-00	Silicon Replaceable by 2N2925		
Q240	*151-0096-00	Selected from 2N1893		
Q260	*151-0104-00	Silicon Replaceable by 2N2919		
Q280	*151-0155-00	Silicon Replaceable by 2N2925		
Q290	*151-0155-00	Silicon Replaceable by 2N2925		
Q310	151-0173-00	Silicon 2N3478		
Q320	*151-0153-00	Silicon Replaceable by 2N2923		

²Part of Sweeper Circuit Board.

Electrical Parts List—Type 1L20

Transistors (Cont)

Ckt. No.	Tektronix Part No.	Description	S/N Range
Q340	151-0173-00	Silicon 2N3478	
Q350	151-0173-00	Silicon 2N3478	
Q420	151-0181-00	Silicon 40242 (RCA)	
Q430	151-0181-00	Silicon 40242 (RCA)	
Q440	151-0175-00	Silicon 2N3662	
Q450	151-0175-00	Silicon 2N3662	
Q460	151-0175-00	Silicon 2N3662	
Q510	151-0181-00	Silicon 40242 (RCA)	
Q520	151-0175-00	Silicon 2N3662	
Q530	151-0175-00	Silicon 2N3662	
Q650	151-0175-00	Silicon 2N3662	
Q710	151-0164-00	Silicon 2N3702	
Q717	151-0174-00	Silicon 2N3403	
Q720	151-0164-00	Silicon 2N3702	
Q727	151-0174-00	Silicon 2N3403	
Q800	*151-0108-00	Silicon Replaceable by 2N2501	
Q820	*151-0108-00	Silicon Replaceable by 2N2501	
Q830	*151-0096-00	Silicon Selected from 2N1893	
Q840	*151-0108-00	Silicon Replaceable by 2N2501	
Q860	*151-0155-00	Silicon Replaceable by 2N2925	
Q870	*151-0155-00	Silicon Replaceable by 2N2925	

Resistors

Resistors are fixed, composition, $\pm 10\%$ unless otherwise indicated.

R10	315-0510-00	51 Ω	$\frac{1}{4}$ W		5%
R14	315-0470-00	47 Ω	$\frac{1}{4}$ W		Selected
R16	315-0470-00	47 Ω	$\frac{1}{4}$ W		Selected
R17	315-0200-00	20 Ω	$\frac{1}{4}$ W		5%
R18	315-0101-00	100 Ω	$\frac{1}{4}$ W		5%
R40	308-0008-00	10 k Ω	5 W		WW 5%
R47	308-0258-00	6 k Ω	3 W		WW 5%
R49	308-0394-00	225 Ω	5 W		WW
R66	311-0546-00	10 k Ω		Var	
R123	315-0101-00	100 Ω	$\frac{1}{4}$ W		5%
R128	315-0332-00	3.3 k Ω	$\frac{1}{4}$ W		5%
R130	315-0221-00	220 Ω	$\frac{1}{4}$ W		5%
R133	315-0101-00	100 Ω	$\frac{1}{4}$ W		5%
R134	315-0131-00	130 Ω	$\frac{1}{4}$ W		5%
R137	315-0101-00	100 Ω	$\frac{1}{4}$ W		5%
R138	315-0182-00	1.8 k Ω	$\frac{1}{4}$ W		5%
R140	315-0221-00	220 Ω	$\frac{1}{4}$ W		5%
R143	315-0101-00	100 Ω	$\frac{1}{4}$ W		5%
R148	315-0101-00	100 Ω	$\frac{1}{4}$ W		5%
R149	315-0472-00	4.7 k Ω	$\frac{1}{4}$ W		5%

Resistors (Cont)

Ckt. No.	Tektronix Part No.	Description	S/N Range
R158	315-0620-00	62 Ω 1/4 W	5%
R159	315-0241-00	240 Ω 1/4 W	5%
R160	315-0620-00	62 Ω 1/4 W	5%
R163	315-0680-00	68 Ω 1/4 W	5%
R164	315-0151-00	150 Ω 1/4 W	5%
R165	315-0680-00	68 Ω 1/4 W	5%
R168	315-0121-00	120 Ω 1/4 W	5%
R169	315-0510-00	51 Ω 1/4 W	5%
R170	315-0121-00	120 Ω 1/4 W	5%
R173	315-0221-00	220 Ω 1/4 W	5%
R174	315-0240-00	24 Ω 1/4 W	5%
R175	315-0221-00	220 Ω 1/4 W	5%
R178	315-0431-00	430 Ω 1/4 W	5%
R179	315-0120-00	12 Ω 1/4 W	5%
R180	315-0431-00	430 Ω 1/4 W	5%
R183	315-0911-00	910 Ω 1/4 W	5%
R184	307-0107-00	5.6 Ω 1/4 W	5%
R185	315-0911-00	910 Ω 1/4 W	5%
R201	321-0332-00	28 k Ω 1/8 W	Prec 1%
R202	321-0358-00	52.3 k Ω 1/8 W	Prec 1%
R204	311-0465-00	100 k Ω	Var
R205	323-0395-00	127 k Ω 1/2 W	Prec 1%
R206	315-0362-00	3.6 k Ω 1/4 W	5%
R208	311-0310-00	5 k Ω	Var
R209	315-0512-00	5.1 k Ω 1/4 W	5%
R213	321-0231-00	2.49 k Ω 1/8 W	Prec 1%
R214	321-0164-00	499 Ω 1/8 W	Prec 1%
R215	321-0193-00	1 k Ω 1/8 W	Prec 1%
R217	321-0164-00	499 Ω 1/8 W	Prec 1%
R219	321-0135-00	249 Ω 1/8 W	Prec 1%
R220	321-0068-00	49.9 Ω 1/8 W	Prec 1%
R221	321-0097-00	100 Ω 1/8 W	Prec 1%
R223	321-0068-00	49.9 Ω 1/8 W	Prec 1%
R224	321-0047-00	30.1 Ω 1/8 W	Prec 1%
R225	321-0001-00	10 Ω 1/8 W	Prec 1%
R226	321-0001-00	10 Ω 1/8 W	Prec 1%
R230	315-0512-00	5.1 k Ω 1/4 W	5%
R231	315-0204-00	200 k Ω 1/4 W	5%
R236	303-0513-00	51 k Ω 1 W	5%
R240	321-0260-00	4.99 k Ω 1/8 W	Prec 1%
R241	323-0414-00	200 k Ω 1/2 W	Prec 1%
R243	304-0124-00	120 k Ω 1 W	
R244	315-0432-00	4.3 k Ω 1/4 W	5%
R245	315-0272-00	2.7 k Ω 1/4 W	5%
R246	316-0102-00	1 k Ω 1/4 W	
R248	316-0101-00	100 Ω 1/4 W	

Electrical Parts List—Type 1L20

Resistors (Cont)

Ckt. No.	Tektronix Part No.	Description		S/N Range	
R252	311-0310-00	5 kΩ		Var	
R253	311-0329-00	50 kΩ		Var	
R254	323-0440-00	374 kΩ	1/2 W		Prec 1%
R255	316-0101-00	100 Ω	1/4 W		
R256	323-0440-00	374 kΩ	1/2 W		Prec 1%
R260	321-0385-00	100 kΩ	1/8 W		Prec 1%
R261	321-0385-00	100 kΩ	1/8 W		Prec 1%
R264	321-0147-00	332 Ω	1/8 W		Prec 1%
R265	321-0147-00	332 Ω	1/8 W		Prec 1%
R266	321-0147-00	332 Ω	1/8 W		Prec 1%
R267	323-0402-00	150 kΩ	1/2 W		Prec 1%
R268	321-0431-00	301 kΩ	1/8 W		Prec 1%
R269	321-0452-00	499 kΩ	1/8 W		Prec 1%
R270	311-0580-00	50 kΩ		Var	
R271	301-0755-00	7.5 MΩ	1/2 W		5%
R274	311-0590-00	2 kΩ		Var	
R276	322-0469-00	750 kΩ	1/4 W		Prec 1%
R280	321-0423-00	249 kΩ	1/8 W		Prec 1%
R286	315-0512-00	5.1 kΩ	1/4 W		5%
R290	311-0443-00	2.5 kΩ		Var	
R291	323-0402-00	150 kΩ	1/2 W		Prec 1%
R293	315-0510-00	51 Ω	1/4 W		5%
R294	316-0562-00	5.6 kΩ	1/4 W		
R295	315-0202-00	2 kΩ	1/4 W		5%
R296	316-0102-00	1 kΩ	1/4 W		
R300	315-0102-00	1 kΩ	1/4 W		5%
R310	315-0562-00	5.6 kΩ	1/4 W		5%
R311	315-0392-00	3.9 kΩ	1/4 W		5%
R316	315-0221-00	220 Ω	1/4 W		5%
R333	321-0233-00	2.61 kΩ	1/8 W		Prec 1%
R334	315-0431-00	430 Ω	1/4 W		5%
R346	315-0680-00	68 Ω	1/4 W		5%
R356	315-0680-00	68 Ω	1/4 W		5%
R361	321-0395-00	127 kΩ	1/8 W		Prec 1%
R363	315-0221-00	220 Ω	1/4 W		5%
R365	315-0102-00	1 kΩ	1/4 W		5%
R368	311-0387-00	5 kΩ		Var	
R373	321-0068-00	49.9 Ω	1/8 W		Prec 1%
R376	321-0068-00	49.9 Ω	1/8 W		Prec 1%
R380	316-0272-00	2.7 kΩ	1/4 W		
R381	316-0274-00	270 kΩ	1/4 W		
R383	315-0681-00	680 Ω	1/4 W		5%
R384	321-0097-00	100 Ω	1/8 W		Prec 1%
R385	321-0097-00	100 Ω	1/8 W		Prec 1%
R401	315-0680-00	68 Ω	1/4 W		5%
R410	315-0393-00	39 kΩ	1/4 W		5%
R411A } R411B }	311-0588-00	5 kΩ 1 kΩ		Var	

Resistors (Cont)

Ckt. No.	Tektronix Part No.		Description		S/N Range
R414	315-0512-00	5.1 k Ω	1/4 W		5%
R416	315-0102-00	1 k Ω	1/4 W		5%
R426	315-0102-00	1 k Ω	1/4 W		5%
R436	315-0102-00	1 k Ω	1/4 W		5%
R448	315-0472-00	4.7 k Ω	1/4 W		5%
R454	315-0103-00	10 k Ω	1/4 W		5%
R456	315-0472-00	4.7 k Ω	1/4 W		5%
R464	315-0103-00	10 k Ω	1/4 W		5%
R466	315-0472-00	4.7 k Ω	1/4 W		5%
R501	317-0151-00	150 Ω	1/10 W		5%
R502	317-0151-00	150 Ω	1/10 W		5%
R514	315-0470-00	47 Ω	1/4 W		5%
R516	315-0242-00	2.4 k Ω	1/4 W		5%
R517	315-0242-00	2.4 k Ω	1/4 W		5%
R524	315-0470-00	47 Ω	1/4 W		5%
R525	315-0202-00	2 k Ω	1/4 W		5%
R530	315-0301-00	300 Ω	1/4 W		5%
R531	315-0203-00	20 k Ω	1/4 W		5%
R532	315-0562-00	5.6 k Ω	1/4 W		5%
R534	315-0102-00	1 k Ω	1/4 W		5%
R537	315-0101-00	100 Ω	1/4 W		5%
R539	315-0102-00	1 k Ω	1/4 W		5%
R540	301-0433-00	43 k Ω	1/2 W		5%
R541	315-0204-00	200 k Ω	1/4 W		5%
R543	311-0326-00	10 k Ω		Var	
R550	315-0151-00	150 Ω	1/4 W		5%
R551	315-0161-00	160 Ω	1/4 W		5%
R552	315-0111-00	110 Ω	1/4 W		5%
R553	315-0151-00	150 Ω	1/4 W		5%
R554	315-0331-00	330 Ω	1/4 W		5%
R555	315-0511-00	510 Ω	1/4 W		5%
R556	315-0561-00	560 Ω	1/4 W		5%
R557	315-0104-00	100 k Ω	1/4 W		5%
R558	315-0394-00	390 k Ω	1/4 W		5%
R559	315-0394-00	390 k Ω	1/4 W		5%
R606	316-0102-00	1 k Ω	1/4 W		
R607	316-0471-00	470 Ω	1/4 W		
R610	316-0102-00	1 k Ω	1/4 W		
R623	316-0101-00	100 Ω	1/4 W		
R624	316-0103-00	10 k Ω	1/4 W		
R626	316-0680-00	68 Ω	1/4 W		
R628	316-0101-00	100 Ω	1/4 W		
R651	316-0104-00	100 k Ω	1/4 W		
R652	316-0105-00	1 M Ω	1/4 W		
R653	308-0313-00	20 k Ω	3 W	WW	1%

Electrical Parts List—Type 1L20

Resistors (Cont)

Ckt. No.	Tektronix Part No.		Description		S/N Range
R654	316-0471-00	470 Ω	1/4 W		
R656	316-0332-00	3.3 kΩ	1/4 W		
R657	316-0332-00	3.3 kΩ	1/4 W		
R658	316-0681-00	680 Ω	1/4 W		
R662	316-0124-00	120 kΩ	1/4 W		
R663	316-0124-00	120 kΩ	1/4 W		
R664	316-0683-00	68 kΩ	1/4 W		
R665	316-0102-00	1 kΩ	1/4 W		
R666	311-0382-00	1 MΩ		Var	
R668	316-0104-00	100 kΩ	1/4 W		
R669	323-0071-00	53.6 Ω	1/2 W		Prec 1%
R671	301-0512-00	5.1 kΩ	1/2 W		5%
R672	311-0091-00	1 kΩ		Var	
R673	303-0123-00	12 kΩ	1 W		5%
R675	316-0471-00	470 Ω	1/4 W		
R676	316-0471-00	470 Ω	1/4 W		
R710	323-0438-00	357 kΩ	1/2 W		Prec 1%
R711	321-0288-00	9.76 kΩ	1/8 W		Prec 1%
R714	316-0103-00	10 kΩ	1/4 W		
R720	321-0289-00	10 kΩ	1/8 W		Prec 1%
R721	321-0284-00	8.87 kΩ	1/8 W		Prec 1%
R724	301-0154-00	150 kΩ	1/2 W		5%
R727	308-0020-00	3 kΩ	10 W		WW 5%
R800	315-0562-00	5.6 kΩ	1/4 W		5%
R801	315-0472-00	4.7 kΩ	1/4 W		5%
R805	315-0102-00	1 kΩ	1/4 W		5%
R812	315-0510-00	51 Ω	1/4 W		5%
R821	301-0183-00	18 kΩ	1/2 W		5%
R823	315-0181-00	180 Ω	1/4 W		5%
R830	315-0103-00	10 kΩ	1/4 W		5%
R831	311-0453-00	10 kΩ		Var	
R832	315-0333-00	33 kΩ	1/4 W		5%
R841	315-0510-00	51 Ω	1/4 W		5%
R844	308-0293-00	4 kΩ	3 W		WW 5%
R846	308-0307-00	5 kΩ	3 W		WW 1%
R850	317-0510-00	51 Ω	1/10 W		5%
R851	321-0193-00	1 kΩ	1/8 W		Prec 1%
R852	321-0193-00	1 kΩ	1/8 W		Prec 1%
R855	317-0510-00	51 Ω	1/10 W		5%
R856	321-0193-00	1 kΩ	1/8 W		Prec 1%
R857	321-0193-00	1 kΩ	1/8 W		Prec 1%
R860	315-0104-00	100 kΩ	1/4 W		5%
R861	315-0101-00	100 Ω	1/4 W		5%
R862	311-0546-00	10 kΩ		Var	
R863	315-0103-00	10 kΩ	1/4 W		5%

Resistors (Cont)

Ckt. No.	Tektronix Part No.		Description		S/N Range
R864	321-0402-00	150 kΩ	1/8 W	Prec	1%
R865	321-0277-00	7.5 kΩ	1/8 W	Prec	1%
R868	315-0101-00	100 Ω	1/4 W		5%
R869	315-0154-00	150 kΩ	1/4 W		5%
R873	315-0753-00	75 kΩ	1/4 W		5%
R874	321-0402-00	150 kΩ	1/8 W	Prec	1%
R875	321-0277-00	7.5 kΩ	1/8 W	Prec	1%
R876	315-0471-00	470 Ω	1/4 W		5%
R886	316-0126-00	12 MΩ	1/4 W		
R887	315-0104-00	100 kΩ	1/4 W		5%
R888	315-0104-00	100 kΩ	1/4 W		5%
R890	301-0100-00	10 Ω	1/2 W		5%
R892	301-0101-00	100 Ω	1/2 W		5%
R894	301-0101-00	100 Ω	1/2 W		5%

Switches

	Unwired	Wired		
SW40 } SW70 }		*262-0761-00	Toggle Toggle	RF INPUT
SW159	260-0642-00		Toggle	IF ATTEN 20 dB
SW164	260-0642-00		Toggle	IF ATTEN 16 dB
SW169	260-0642-00		Toggle	IF ATTEN 8 dB
SW174	260-0642-00		Toggle	IF ATTEN 4 dB
SW179	260-0642-00		Toggle	IF ATTEN 2 dB
SW184	260-0642-00		Toggle	IF ATTEN 1 dB
SW201	260-0583-00		Slide	
SW220 ³	260-0759-00	*262-0763-00	Rotary	DISPERSION
SW230	260-0757-00		Rotary	DISPERSION RANGE
SW365	260-0643-00		Toggle	
SW550 ³			Rotary	COUPLED RESOLUTION
SW660	260-0758-00	*262-0762-00	Lever	VERTICAL DISPLAY
SW661	260-0643-00		Toggle	VIDEO FILTER
SW810	260-0642-00		Toggle	INT 1 MHz REF FREQ
SW889	260-0689-00		Push	LOCK CHECK

Transformers

T14	*120-0340-00	Toroid, 5 turns bifilar
T120	*120-0428-00	Toroid, 5 turns bifilar
T124	*120-0325-00	Toroid, 5 turns bifilar
T134	*120-0325-00	Toroid, 5 turns bifilar
T148	*120-0325-00	Toroid, 5 turns bifilar

³SW220 and SW550 furnished as a unit.

Transformers (Cont)

Ckt. No.	Tektronix Part No.	Description	S/N Range
T330	*120-0340-00	Toroid, 5 turns bifilar	
T331	*120-0340-00	Toroid, 5 turns bifilar	
T343	*120-0340-00	Toroid, 5 turns bifilar	
T347	*120-0340-00	Toroid, 5 turns bifilar	
T354	*120-0340-00	Toroid, 5 turns bifilar	
T363	*120-0340-00	Toroid, 5 turns bifilar	
T424	*120-0425-00	Toroid, 4 turns—1 turn	
T434	*120-0426-00	Toroid, 7 turns—2 turns	
T454	120-0356-00	3.45 MHz	
T464	120-0356-00	3.45 MHz	
T610	*120-0427-00	Toroid, 12 turns	
T820	*120-0370-00	Toroid, 3 windings	

Electron Tubes

V40	154-0499-00	Y-1506
V41	154-0499-00	Y-1506
V620	154-0040-00	12AU6

Cable Assemblies

W1	*175-0362-00	10 inch
W14	*175-0310-00	6 inch
W19	*175-0367-00	2 inch
W34	*175-0367-00	2 inch
W40	*175-0310-00	6 inch
W41	*175-0313-00	3 inch
W66	*175-0312-00	9 inch
W70	*175-0358-00	1 ⁷ / ₁₆ inch
W75	*175-0308-00	2 inch
W94	*175-0364-00	11 inch
W110	*175-0308-00	2 inch
W150	*175-0313-00	3 inch
W200	*175-0358-00	1 ⁷ / ₁₆ inch
W300	*175-0358-00	1 ⁷ / ₁₆ inch
W370 ⁴		
W375 ⁴		
W500	*175-0358-00	1 ⁷ / ₁₆ inch

Crystals

Y440	158-0024-00	70 MHz
Y501	158-0019-00	5 MHz
Y610	158-0027-00	5 MHz
Y800	158-0025-00	1 MHz

Mixer

*119-0064-00	275-4200	MHz	Mixer (includes D64)
--------------	----------	-----	----------------------

1 dB Pad

R60	119-0066-00	Attenuator Pad
-----	-------------	----------------

Oscillator

119-0063-00	Dual Oscillator (includes V40 and V41)
-------------	--

⁴Selected. See Mechanical Parts List.

FIGURE AND INDEX NUMBERS

Items in this section are referenced by figure and index numbers to the illustrations which appear on the pullout pages immediately following the Diagrams section of this instruction manual.

INDENTATION SYSTEM

This mechanical parts list is indented to indicate item relationships. Following is an example of the indentation system used in the Description column.

Assembly and/or Component
Detail Part of Assembly and/or Component
mounting hardware for Detail Part
Parts of Detail Part
mounting hardware for Parts of Detail Part
mounting hardware for Assembly and/or Component

Mounting hardware always appears in the same indentation as the item it mounts, while the detail parts are indented to the right. Indented items are part of, and included with, the next higher indentation.

Mounting hardware must be purchased separately, unless otherwise specified.

PARTS ORDERING INFORMATION

Replacement parts are available from or through your local Tektronix, Inc. Field Office or representative.

Changes to Tektronix instruments are sometimes made to accommodate improved components as they become available, and to give you the benefit of the latest circuit improvements developed in our engineering department. It is therefore important, when ordering parts, to include the following information in your order: Part number, instrument type or number, serial or model number, and modification number if applicable.

If a part you have ordered has been replaced with a new or improved part, your local Tektronix, Inc. Field Office or representative will contact you concerning any change in part number.

Change information, if any, is located at the rear of this manual.

ABBREVIATIONS AND SYMBOLS

For an explanation of the abbreviations and symbols used in this section, please refer to the page immediately preceding the Electrical Parts List in this instruction manual.

INDEX OF MECHANICAL PARTS LIST ILLUSTRATIONS

- | | |
|--------|---------------------------------------|
| FIG. 1 | FRONT |
| FIG. 2 | REAR & CHASSIS |
| FIG. 3 | IF CHASSIS |
| FIG. 4 | LOW PASS FILTER & PHASE LOCK ASSEMBLY |
| FIG. 5 | ACCESSORIES |

SECTION 8

MECHANICAL PARTS LIST

FIG. 1 FRONT

Fig. & Index No.	Tektronix Part No.	Serial/Model Eff	No. Disc	Q					Description
				t	1	2	3	4	
1-1	333-0924-00			1					PANEL, front
-2	366-0153-00			1					KNOB, charcoal—POS
	- - - - -			-					knob includes:
	213-0004-00			1					SCREW, set, 6-32 x 3/16 inch, HSS
-3	- - - - -			3					RESISTOR, variable
	- - - - -			-					mounting hardware for each: (not included w/resistor)
	210-0046-00			1					LOCKWASHER, internal, 1/4 ID x 0.400 inch OD
	210-0940-00			1					WASHER, flat, 1/4 ID x 3/4 inch OD
	210-0583-00			1					NUT, hex., 1/4-32 x 5/16 inch
-4	366-0153-00			1					KNOB, charcoal—FINE IF CENTER FREQ
	- - - - -			-					knob includes:
	213-0004-00			1					SCREW, set, 6-32 x 3/16 inch, HSS
-5	- - - - -			1					RESISTOR, variable
	- - - - -			-					mounting hardware: (not included w/resistor)
	210-0223-00			1					LUG, solder, 1/4 ID x 7/16 inch OD, SE
	210-0940-00			1					WASHER, flat, 1/4 ID x 3/8 inch OD
	210-0583-00			1					NUT, hex., 1/4-32 x 5/16 inch
-6	366-0153-00			1					KNOB, charcoal—DISPERSION RANGE
	- - - - -			-					knob includes:
	213-0004-00			1					SCREW, set, 6-32 x 3/16 inch, HSS
-7	384-0394-00			1					ROD, shaft
-8	214-0694-00			1					CAM, control actuator
	- - - - -			-					cam includes:
	213-0022-00			2					SCREW, set, 4-40 x 3/16 inch, HSS
-9	376-0029-00			1					COUPLING, shaft
	- - - - -			-					coupling includes:
	213-0075-00			2					SCREW, set, 4-40 x 3/32 inch, HSS
-10	366-0295-00			1					KNOB, charcoal—COUPLED RESOLUTION
	- - - - -			-					knob includes:
	213-0048-00			1					SCREW, set, 4-40 x 1/8 inch, HSS
-11	366-0296-00			1					KNOB, charcoal—DISPERSION
	- - - - -			-					knob includes:
	213-0048-00			1					SCREW, set, 4-40 x 1/8 inch, HSS
-12	262-0763-00			1					SWITCH, wired—COUPLED RESOLUTION—DISPERSION
	- - - - -			-					switch includes:
	260-0759-00			1					SWITCH, unwired—COUPLED RESOLUTION—DISPERSION
	- - - - -			-					mounting hardware: (not included w/switch)
	210-0590-00			1					NUT, hex., 3/8-32 x 7/16 inch
-13	366-0153-00			1					KNOB, charcoal—MIXER PEAKING
	- - - - -			-					knob includes:
	213-0004-00			1					SCREW, set, 6-32 x 3/16 inch, HSS

FIG. 1 FRONT (Cont)

Fig. & Index No.	Tektronix Part No.	Serial/Model Eff	No. Disc	Q					Description	
				t	y	1	2	3		4
1-14	331-0168-00			1						DIAL, w/o brake—IF CENTER FREQ
	- - - - -			-						dial includes:
	213-0048-00			1						SCREW, set, 4-40 x 1/8 inch, HSS
-15	- - - - -			2						RESISTOR, variable
	- - - - -			-						mounting hardware for each: (not included w/resistor)
	210-0046-00			1						LOCKWASHER, internal, 1/4 ID x 0.400 inch OD
	210-0471-00			1						NUT, hex., 1/4-32 x 5/16 inch
	358-0054-00			1						BUSHING, 1/4-32 x 3/32 inch
-16	366-0153-00			1						KNOB, charcoal—GAIN
	- - - - -			-						knob includes:
	213-0004-00			1						SCREW, set, 6-32 x 3/16 inch, HSS
-17	260-0643-00			1						SWITCH, unwired—VIDEO FILTER
	- - - - -			-						mounting hardware: (not included w/switch)
	210-0046-00			1						LOCKWASHER, internal, 1/4 ID x 0.400 inch OD
	210-0940-00			1						WASHER, flat, 1/4 ID x 3/8 inch OD
	210-0562-00			1						NUT, hex., 1/4-40 x 5/16 inch
-18	366-0351-00			1						KNOB, charcoal—RF INPUTS
-19	262-0761-00			1						SWITCH, wired—RF INPUTS
	- - - - -			-						mounting hardware: (not included w/switch)
	210-0940-00			2						WASHER, flat, 1/4 ID x 3/8 inch OD
-20	366-0215-01			1						KNOB, charcoal—VERTICAL DISPLAY
-21	262-0762-00			1						SWITCH, lever—VERTICAL DISPLAY
	- - - - -			-						switch includes:
	260-0758-00			1						SWITCH, unwired—VERTICAL DISPLAY
	- - - - -			-						mounting hardware: (not included w/switch)
	211-0005-00			2						SCREW, 4-40 x 1/8 inch, PHS
-22	366-0284-00			1						KNOB, charcoal—RF CENTER FREQ
	- - - - -			-						knob includes:
	213-0020-00			1						SCREW, set, 6-32 x 1/8 inch, HSS
	632-0009-00			1						ASSEMBLY, OSCILLATOR
	- - - - -			-						assembly includes:
-23	119-0063-00			1						OSCILLATOR
-24	384-0634-00			1						ROD, shaft drive
	- - - - -			-						mounting hardware: (not included w/rod)
-25	213-0075-00			2						SCREW, set, 4-40 x 3/32 inch, HSS
-26	214-0522-00			2						GEAR
-27	384-0635-00			1						ROD, sprocket
-28	210-1011-00			1						WASHER, non-metallic
-29	210-0992-00			1						WASHER, spacer, plastic, 0.265 ID x 0.437 inch OD
-30	214-0520-00			1						SPROCKET, tape
	- - - - -			-						mounting hardware: (not included w/sprocket)
-31	213-0075-00			1						SCREW, set, 4-40 x 3/32 inch, HSS

FIG. 1 FRONT (Cont)

Fig. & Index No.	Tektronix Part No.	Serial/Model No. Eff	No. Disc	Q † y	1 2 3 4 5					Description
					1	2	3	4	5	
1-32	214-0521-00			2						ROLLER, idler tape
	- - - - -			-						mounting hardware for each: (not included w/roller)
-33	384-0636-00			1						ROD, idler standoff
	-34	380-0076-00		1						HOUSING, dial
	- - - - -			-						housing includes:
-35	214-0564-00			1						PIN, roll
	- - - - -			-						mounting hardware: (not included w/housing)
-36	211-0595-00			2						SCREW, 6-32 x 1/4 inch, socket head cap
	-37	358-0298-00		1						BUSHING
	- - - - -			-						mounting hardware: (not included w/assembly)
-38	407-0228-00			1						BRACKET, mounting
-39	212-0516-00			1						SCREW, 10-32 x 2 inches, HHS
	210-0805-00			1						WASHER, flat, 0.204 ID x 0.438 inch OD (not shown)
	210-0840-00			1						WASHER, flat, 0.390 ID x 9/16 inch OD (not shown)
	211-0507-00			1						SCREW, 6-32 x 5/16 inch, PHS (not shown)
	-40	331-0166-00		1						TAPE, dial
	-41	175-0310-00		1						ASSEMBLY, cable, 6 inches (OSC front to J14)
	-42	175-0310-00		1						ASSEMBLY, cable, 6 inches (OSC front to J850)
	-43	175-0312-00		1						ASSEMBLY, cable, 9 inches (OSC rear to J65)
	-44	175-0313-00		1						ASSEMBLY, cable, 3 inches (OSC rear to J855)
	-45	386-1026-00		1						PLATE, sub-panel front
	-46	131-0106-00		2						CONNECTOR, coaxial, 1 contact, BNC, w/nut
	-47	210-0255-00		1						LUG, solder, 3/8 inch
	-48	366-0125-00		1						KNOB, plug-in securing
	- - - - -			-						knob includes:
	213-0004-00			1						SCREW, set, 6-32 x 3/16 inch, HSS
	-49	210-0894-00		1						WASHER, plastic, 0.190 ID x 7/16 inch OD
	-50	354-0025-00		1						RING, retaining
	-51	384-0510-00		1						ROD, securing
	-52	136-0094-00		1						SOCKET
	- - - - -			-						mounting hardware: (not included w/socket)
	210-0940-00			2						WASHER, flat, 1/4 ID x 3/8 inch OD
	210-0583-00			1						NUT, hex., 1/4-32 x 5/16 inch
	-53	175-0367-00		1						ASSEMBLY, cable, 2 inches (J71 to J34)
	-54	175-0308-00		1						ASSEMBLY, cable, 2 inches (J75 to J80)
	-55	175-0358-00		1						ASSEMBLY, cable, 1 9/16 inches (J73 to J69)
	-56	136-0140-00		1						SOCKET, banana jack
	- - - - -			-						mounting hardware: (not included w/socket)
	210-0895-00			1						WASHER, insulating, 0.375 dia x 0.105 inch thick
	210-0465-00			2						NUT, hex., 1/4-32 x 3/8 inch
	210-0223-00			1						LUG, solder, 1/4 ID x 7/16 inch OD, SE
	-57	384-0631-00		4						ROD, spacer
	- - - - -			-						mounting hardware for each: (not included w/rod)
	212-0044-00			1						SCREW, 8-32 x 1/2 inch, RHS (not shown)
	-58	386-0115-01		1						PLATE, dial window
	- - - - -			-						mounting hardware: (not included w/plate)
	213-0138-00			2						SCREW, sheet metal, #4 x 3/16 inch, PHS

FIG. 1 FRONT (Cont)

Fig. & Index No.	Part No. Tektronix	Serial/Model Eff	No. Disc	Q					Description	
				t	y	1	2	3		4
1-59	119-0064-00			1						MIXER, w/crystal
	- - - - -			-						mounting hardware: (not included w/mixer)
-60	210-0579-00			1						NUT, hex., 5/8-24 x 3/4 inch
	210-1010-00			1						WASHER, flat, 0.643 ID x 0.875 inch OD
-61	119-0066-00			1						ATTENUATOR, pad
-62	103-0057-00			1						ADAPTER, connector
-63	175-0362-00			1						ASSEMBLY, cable, 10 inches (J1 to J10)
-64	179-1049-00			1						CABLE HARNESS, phase lock
	- - - - -			-						cable harness includes:
-65	131-0371-00			8						CONNECTOR, single contact
-66	352-0086-00			1						HOLDER, toroid
-67	366-0153-00			1						KNOB, charcoal—FINE FREQ
	- - - - -			-						knob includes:
	213-0004-00			1						SCREW, set, 6-32 x 3/16 inch, HHS

FIG. 2 REAR & CHASSIS

Fig. & Index No.	Tektronix Part No.	Serial/Model No. Eff	No. Disc	Q					Description	
				f	y	1	2	3		4
2-1	386-1025-00			1						PLATE, rear
-2	131-0017-00			1						CONNECTOR, 16 contact, male
	- - - - -			-						mounting hardware: (not included w/connector)
-3	211-0008-00			2						SCREW, 4-40 x 1/4 inch, PHS
-4	210-0586-00			2						NUT, keps, 4-40 x 1/4 inch
-5	260-0583-00			1						SWITCH, unwired—SW201
	- - - - -			-						mounting hardware: (not included w/switch)
-6	211-0022-00			2						SCREW, 2-56 x 3/16 inch, RHS
	210-0405-00			2						NUT, hex., 2-56 x 3/16 inch
-7	- - - - -			2						RESISTOR
	- - - - -			-						mounting hardware for each: (not included w/resistor)
-8	211-0544-00			1						SCREW, 6-32 x 3/4 inch, THS
-9	210-0478-00			1						NUT, hex., 5/16 x 2 1/32 inch long
-10	211-0507-00			1						SCREW, 6-32 x 5/16 inch, PHS
-11	- - - - -			1						RESISTOR
	- - - - -			-						mounting hardware: (not included w/resistor)
-12	211-0553-00			1						SCREW, 6-32 x 1 1/2 inches, RHS
-13	210-0601-00			1						EYELET
-14	210-0478-00			1						NUT, hex., 5/16 x 2 1/32 inch long
-15	211-0507-00			1						SCREW, 6-32 x 5/16 inch, PHS
-16	210-0202-00			1						LUG, solder, SE #6
	- - - - -			-						mounting hardware: (not included w/lug)
-17	211-0504-00			1						SCREW, 6-32 x 1/4 inch, PHS
-18	210-0407-00			1						NUT, hex., 6-32 x 1/4 inch
-19	386-1031-00			1						PLATE, switch mount
-20	384-0616-00			2						ROD, spacer, hex., 1/4 x 1.370 inch long
-21	211-0008-00			4						SCREW, 4-40 x 1/4 inch, PHS
-22	210-0201-00			2						LUG, solder, SE #4
-23	260-0757-00			1						SWITCH, unwired—DISPERSION RANGE
	- - - - -			-						mounting hardware: (not included w/switch)
-24	210-0583-00			1						NUT, hex., 1/4-32 x 5/16 inch
-25	210-0940-00			1						WASHER, flat, 1/4 ID x 3/8 inch OD
-26	210-0046-00			1						LOCKWASHER, internal, 1/4 ID x 0.400 inch OD
	610-0169-00			1						ASSEMBLY, 10-275 MHz MIXER 'B'
	- - - - -			-						assembly includes:
-27	386-1037-00			1						PLATE
-28	211-0106-00			4						SCREW, 4-40 x 5/8 inch, FHS
-29	380-0097-00			1						HOUSING

FIG. 2 REAR & CHASSIS (Cont)

Fig. & Index No.	Tektronix Part No.	Serial/Model Eff	No. Disc	Q † y	1 2 3 4 5					Description
					1	2	3	4	5	
2-30	131-0373-00			4						CONNECTOR, stand-off
	- - - - -			-						mounting hardware for each: (not included w/conector)
-31	210-0001-00			1						LOCKWASHER, internal, #2
-32	210-0405-00			1						NUT, hex., 4-40 x 3/16 inch
-33	131-0372-00			3						CONNECTOR, coaxial, w/hardware
-34	441-0671-00			1						CHASSIS
-35	210-0599-00			4						NUT, sleeve, 1/4 dia x 0.391 inch long
	- - - - -			-						mounting hardware: (not included w/assembly)
-36	211-0008-00			2						SCREW, 4-40 x 1/4 inch, PHS
-37	175-0367-00			1						ASSEMBLY, cable, 2 inch (J18 to J20)
-38	- - - - -			-						ASSEMBLY, cable, 10 inch (J10 to J1) (see FIG. 1 FRONT)
-39	- - - - -			-						ASSEMBLY, cable, 6 inch (J14 to OSC FRONT) (see FIG. 1 FRONT)
-40	- - - - -			5						RESISTOR, variable
	- - - - -			-						mounting hardware for each: (not included w/resistor)
-41	210-0046-00			2						LOCKWASHER, internal, 1/4 ID x 0.400 inch OD
-42	210-0471-00			1						NUT, hex., 1/4-32 x 19/32 inch long
-43	358-0054-00			1						BUSHING, 1/4-32 x 13/32 inch long
-44	136-0235-00			1						SOCKET, transistor, dual
	- - - - -			-						mounting hardware: (not included w/socket)
-45	354-0234-00			1						RING, socket mounting
-46	136-0181-00			1						SOCKET, transistor, 3 pin
	- - - - -			-						mounting hardware: (not included w/socket)
-47	354-0234-00			1						RING, socket mounting
-48	136-0218-00			7						SOCKET, transistor, 3 pin
	- - - - -			-						mounting hardware for each: (not included w/socket)
-49	354-0285-00			1						HOLDER, socket
-50	136-0009-00			1						SOCKET, tube, 7 pin, w/shield
	- - - - -			-						mounting hardware: (not included w/socket)
-51	211-0033-00			2						SCREW, sems, 4-40 x 5/16 inch, PHS
	210-0004-00			1						LOCKWASHER, internal, #4 (not shown)
	210-0201-00			1						LUG, solder, SE #4, (not shown)
	210-0406-00			2						NUT, hex., 4-40 x 3/16 inch (not shown)
-52	337-0007-00			1						SHIELD, tube, 7/8 ID x 1 3/4 inch h, w/spring
-53	136-0208-00			1						SOCKET, crystal
	- - - - -			-						mounting hardware: (not included w/socket)
-54	213-0055-00			1						SCREW, thread forming, 2-32 x 3/16 inch, PHS
-55	- - - - -			1						COIL
	- - - - -			-						mounting hardware: (not included w/coil)
	385-0150-00			1						ROD, spacer, 3/8 x 5/8 inch
	210-0204-00			1						LUG, solder, DE #6
	210-0201-00			1						LUG, solder, SE #4
	211-0008-00			1						SCREW, 4-40 x 3/16 inch, PHS

FIG. 2 REAR & CHASSIS (Cont)

Fig. & Index No.	Tektronix Part No.	Serial/Model Eff	No. Disc	Q † y	1 2 3 4 5					Description
					1	2	3	4	5	
2-56	407-0138-00			1						BRACKET
	- - - - -			-						mounting hardware: (not included w/bracket)
-57	213-0088-00			2						SCREW, thread forming, #4 x 1/4 inch, PHS
	-58 348-0056-00			1						GROMMET, plastic, 0.354 ID x 0.406 inch OD
	-59 210-0259-00			5						LUG, solder, #2
	- - - - -			-						mounting hardware for each: (not included w/lug)
-60	213-0055-00			1						SCREW, thread forming, 2-32 x 3/16 inch, PHS
	-61 441-0668-00			1						CHASSIS
	- - - - -			-						mounting hardware: (not included w/chassis)
	211-0538-00			2						SCREW, 6-32 x 5/16 inch, 100° csk, PHS (not shown)
-62	213-0138-00			1						SCREW, sheet metal, #4 x 3/16 inch, PHS
-63	211-0504-00			1						SCREW, 6-32 x 1/4 inch, PHS
	210-0457-00			1						NUT, keps, 6-32 x 5/16 inch (not shown)
	-64 670-0099-00			1						ASSEMBLY, circuit board—RECORDER DETECTOR
	- - - - -			-						assembly includes:
	388-0650-00			1						BOARD, circuit
	-65 124-0148-00			2						STRIP, ceramic, 7/16 inch h, w/9 notches
	- - - - -			-						each strip includes:
	355-0046-00			2						STUD, plastic
	- - - - -			-						mounting hardware for each: (not included w/strip)
	361-0008-00			2						SPACER, plastic, 0.281 inch long
	-66 124-0145-00			4						STRIP, ceramic, 7/16 inch h, w/20 notches
	- - - - -			-						each strip includes:
	355-0046-00			2						STUD, plastic
	- - - - -			-						mounting hardware for each: (not included w/strip)
	361-0009-00			2						SPACER, plastic, 0.406 inch long
	-67 124-0162-00			1						STRIP, ceramic, 7/16 inch h, w/4 notches
	- - - - -			-						strip includes:
	355-0046-00			1						STUD, plastic
	- - - - -			-						mounting hardware: (not included w/strip)
	361-0009-00			1						SPACER, plastic, 0.406 inch long
	-68 179-1044-00			1						CABLE HARNESS, chassis

FIG. 3 IF CHASSIS

Fig. & Index No.	Tektronix Part No.	Serial/Model Eff	No. Disc	Q					Description	
				t	y	1	2	3		4
3-	610-0175-00			1						ASSEMBLY, IF CHASSIS
	- - - - -			-						assembly includes:
	610-0173-00			1						ASSEMBLY, IF ATTENUATOR
	- - - - -			-						assembly includes:
-1	260-0642-00			6						SWITCH, toggle—IF ATTEN dB
-2	337-0799-00			1						SHIELD, switch
	610-0174-00			1						ASSEMBLY, BANDPASS FILTER
	- - - - -			-						assembly includes:
-3	131-0372-00			4						CONNECTOR, coaxial, w/hardware
-4	210-0206-00			2						LUG, solder, SE #10, long
-5	- - - - -			6						CAPACITOR
	- - - - -			-						mounting hardware for each: (not included w/capacitor)
-6	214-0456-00			1						FASTENER, plastic
-7	124-0181-00			2						STRIP, terminal
-8	337-0802-00			1						SHIELD, filter
-9	441-0667-00			1						CHASSIS
	- - - - -			-						mounting hardware: (not included w/chassis)
-10	211-0065-00			2						SCREW, 4-40 x 3/16 inch, PHS
-11	131-0182-00			2						CONNECTOR, terminal feed thru
	- - - - -			-						mounting hardware for each: (not included w/connector)
	358-0135-00			1						BUSHING, plastic
-12	131-0372-00			11						CONNECTOR, coaxial, w/hardware
-13	210-0206-00			2						LUG, solder, #10, long
-14	210-0812-00			3						WASHER, fiber, #6, shouldered
-15	210-0813-00			3						WASHER, fiber, #10, shouldered
-16	131-0373-00			30						CONNECTOR, terminal standoff
-17	136-0153-00			1						SOCKET, crystal, w/clamp
	- - - - -			-						mounting hardware: (not included w/socket)
	211-0022-00			1						SCREW, 2-56 x 3/16 inch, RHS
	210-0405-00			1						NUT, hex., 4-40 x 3/16 inch
	210-0001-00			1						LOCKWASHER, internal #2
-18	136-0217-00			9						SOCKET, transistor, 4 pin
	- - - - -			-						mounting hardware for each: (not included w/socket)
	354-0285-00			1						HOLDER, socket
-19	136-0218-00			6						SOCKET, transistor, 3 pin
	- - - - -			-						mounting hardware for each: (not included w/socket)
	354-0285-00			1						HOLDER, socket
-20	260-0643-00			1						SWITCH, toggle—DISPERSION RANGE
	- - - - -			-						mounting hardware: (not included w/switch)
	214-0695-00			1						WASHER, key, 0.255 ID x 0.375 inch OD
	210-0562-00			1						NUT, hex., 1/4-40 x 5/16 inch
-21	426-0121-00			2						MOUNT, toroid
	- - - - -			-						mounting hardware for each: (not included w/mount)
	361-0007-00			1						SPACER, plastic, 0.188 inch long

FIG. 3 IF CHASSIS (Cont)

Fig. & Index No.	Tektronix Part No.	Serial/Model No. Eff Disc	Q					Description	
			†	y	1	2	3		4
3-22	- - - - -	- - - - -	1						COIL
			-						mounting hardware: (not included w/coil)
-23	385-0150-00		1						ROD, spacer, $\frac{3}{8} \times \frac{5}{8}$ inch
	210-0004-00		1						LOCKWASHER, internal, #4
	211-0008-00		1						SCREW, 4-40 x $\frac{1}{4}$ inch, PHS
-24	210-0001-00		9						LOCKWASHER, internal, #2
-25	210-0259-00		31						LUG, solder, #2
-26	210-0405-00		31						NUT, hex., 4-40 x $\frac{3}{16}$ inch
-27	213-0055-00		6						SCREW, 2-56 x $\frac{3}{16}$ inch, PHS
-28	136-0208-00		1						SOCKET, crystal
-29	337-0801-00		1						SHIELD
-30	337-0803-01		1						SHIELD
-31	388-0683-00		1						BOARD, connector
	- - - - -		-						board includes:
-32	214-0506-00		16						PIN, connector
	- - - - -		-						mounting hardware: (not included w/board)
-33	213-0141-00		2						SCREW, thread forming, 4-40 x $\frac{1}{4}$ inch, PHS
-34	670-0100-00		1						ASSEMBLY, circuit board—SWEEPER
	- - - - -		-						assembly includes:
	388-0684-00		1						BOARD, circuit
-35	441-0666-00		1						CHASSIS
	- - - - -		-						mounting hardware: (not included w/chassis)
-36	211-0065-00		16						SCREW, 4-40 x $\frac{3}{16}$ inch, PHS
-37	175-0308-00		1						ASSEMBLY, cable, 2 inches (J120 to J109)
	175-0313-00		1						ASSEMBLY, cable, 3 inches (J147 to J151)
	175-0384-00		-						¹ ASSEMBLY, cable, black band
	175-0384-01		-						¹ ASSEMBLY, cable, brown band
	175-0384-02		-						¹ ASSEMBLY, cable, red band
	175-0384-03		-						¹ ASSEMBLY, cable, orange band
	175-0384-04		-						¹ ASSEMBLY, cable, yellow band
	175-0358-00		1						ASSEMBLY, cable, $1\frac{7}{16}$ inches (J363 to J148)
	175-0358-00		1						ASSEMBLY, cable, $1\frac{7}{16}$ inches (J501 to J470)
	175-0358-00		1						ASSEMBLY, cable, $1\frac{7}{16}$ inches (J188 to J401)
-38	179-1046-00		1						CABLE HARNESS, IF chassis
	- - - - -		-						mounting hardware: (not included w/assembly)
	211-0507-00		2						SCREW, 6-32 x $\frac{5}{16}$ inch, PHS (not shown)
	210-0562-00		6						NUT, hex., $\frac{1}{4}$ -40 x $\frac{5}{16}$ inch (not shown)
-39	386-1032-00		1						PLATE, IF chassis cover
	- - - - -		-						mounting hardware: (not included w/plate)
-40	211-0065-00		16						SCREW, 4-40 x $\frac{3}{16}$ inch, PHS
-41	211-0105-00		5						SCREW, 4-40 x $\frac{3}{16}$ inch, FHS
-42	175-0364-00		1						ASSEMBLY, cable, 11 inches (J100 to J94)

¹This is a specially selected cable assembly connected from J370 to J373 and J376 to J379. Replace only with a part bearing the same color band as the original part in your instrument.

Mechanical Parts List — Type 1L20

FIG. 4 LOW PASS FILTER & PHASE LOCK ASSEMBLY

Fig. & Index No.	Tektronix Part No.	Serial/Model Eff	No. Disc	Q					Description
				y	1	2	3	4	
4-	644-0014-00			1					ASSEMBLY, PHASE LOCK
	- - - - -			-					assembly includes:
-1	131-0372-00			2					CONNECTOR, coaxial, w/hardware
-2	131-0429-00			1					CONNECTOR, BNC
	- - - - -			-					mounting hardware: (not included w/connector)
-3	211-0105-00			4					SCREW, 4-40 x 3/16 inch, 82° csk, FHS
-4	348-0003-00			1					GROMMET, rubber, 5/16 inch
-5	388-0688-00			1					BOARD, connector
	- - - - -			-					board includes:
-6	214-0507-00			10					PIN, connector
	- - - - -			-					mounting hardware: (not included w/board)
-7	211-0065-00			4					SCREW, 4-40 x 3/16 inch, PHS
-8	220-0455-00			2					NUT, block
-9	- - - - -			1					RESISTOR, variable—FINE FREQ
	- - - - -			-					mounting hardware: (not included w/resistor)
	210-0046-00			1					LOCKWASHER, internal, 1/4 ID x 0.400 inch OD
	210-0583-00			2					NUT, hex., 1/4-32 x 5/16 inch
-10	260-0689-00			1					SWITCH, unwired—LOCK CHECK
	- - - - -			-					mounting hardware: (not included w/switch)
	210-0223-00			1					LUG, solder, 1/4 ID x 7/16 inch OD, SE
	210-0583-00			2					NUT, hex., 1/4-32 x 5/16 inch
-11	260-0642-00			1					SWITCH, unwired—INT 1 MHz, REF FREQ
	- - - - -			-					mounting hardware: (not included w/switch)
	210-0046-00			1					LOCKWASHER, internal, 1/4 ID x 0.400 inch OD
	210-0562-00			2					NUT, hex., 1/4-40 x 5/16 inch
-12	337-0797-00			1					SHIELD
-13	179-1048-00			1					CABLE HARNESS, phase lock board
-14	670-0101-00			1					ASSEMBLY, circuit board
	- - - - -			-					assembly includes:
	388-0682-01			1					BOARD, circuit
-15	136-0183-00			1					SOCKET, transistor, 3 pin
-16	136-0220-00			4					SOCKET, transistor, 3 pin
-17	344-0108-00			10					CLIP, diode mounting
-18	352-0041-00			7					HOLDER
-19	136-0234-00			2					SOCKET, receptacle
-20	352-0096-00			1					HOLDER, crystal
	- - - - -			-					mounting hardware: (not included w/assembly)
-21	211-0105-00			3					SCREW, 4-40 x 3/16 inch, 82° csk, FHS
-22	220-0455-00			4					NUT, block
-23	211-0065-00			6					SCREW, 4-40 x 3/16 inch, PHS
-24	337-0800-00			1					SHIELD, PHASE LOCK
	- - - - -			-					mounting hardware: (not included w/shield)
-25	213-0128-00			6					SCREW, sheet metal, #4 x 3/16 inch, PHS
-26	210-0458-00			1					NUT, keps, 8-32 x 1 1/32 inch
	210-0909-00			1					WASHER, mica, 0.196 ID x 0.625 inch OD
	210-0935-00			1					WASHER, fiber, 0.140 ID x 0.375 inch OD

FIG. 4 LOW PASS FILTER & PHASE LOCK ASSEMBLY (Cont)

Fig. & Index No.	Tektronix Part No.	Serial/Model No.		Q † y	1	2	3	4	5	Description
		Eff	Disc							
4-27	- - - - -			-						ASSEMBLY, cable, 3 inch (J855 to OSC rear) (see FIG. 1 FRONT)
-28	- - - - -			-						ASSEMBLY, cable, 6 inch (J850 to OSC front) (see FIG. 1 FRONT)
	610-0171-00			1						ASSEMBLY, LOW PASS FILTER, 235 MHz
	- - - - -			-						assembly includes:
-29	441-0669-02			1						CHASSIS
-30	337-0806-00			2						SHIELD, 'U' shape
	- - - - -			-						mounting hardware for each: (not included w/shield)
	213-0138-00			1						SCREW, sheet metal, #4 x 3/16 inch, PHS
-31	131-0372-00			2						CONNECTOR, coaxial, w/hardware
-32	337-0805-00			1						SHIELD
	- - - - -			-						mounting hardware: (not included w/shield)
-33	213-0138-00			4						SCREW, sheet metal, #4 x 3/16 inch, PHS
	- - - - -			-						mounting hardware: (not included w/assembly)
-34	213-0138-00			2						SCREW, sheet metal, #4 x 3/16 inch, PHS
-35	- - - - -			-						ASSEMBLY, cable, 2 inch (J20 to J18) (see FIG. 2 REAR & CHASSIS)
-36	- - - - -			-						ASSEMBLY, cable, 2 inch (J34 to J71) (see FIG. 1 FRONT)
	610-0170-00			1						ASSEMBLY, LOW PASS FILTER 265 MHz
	- - - - -			-						assembly includes:
-37	441-0669-01			1						CHASSIS
-38	337-0806-00			2						SHIELD, 'U' shape
	- - - - -			-						mounting hardware for each: (not included w/shield)
	213-0138-00			1						SCREW, sheet metal, #4 x 3/16 inch, PHS
-39	131-0372-00			2						CONNECTOR, coaxial, w/hardware
-40	337-0805-00			1						SHIELD
	- - - - -			-						mounting hardware for each: (not included w/shield alone)
-41	213-0138-00			4						SCREW, sheet metal, #4 x 3/16 inch, PHS
	- - - - -			-						mounting hardware: (not included with assembly)
-42	213-0138-00			2						SCREW, sheet metal, #4 x 3/16 inch, PHS
-43	- - - - -			-						ASSEMBLY, cable (J94 to J100) (see FIG. 3 IF CHASSIS)
-44	- - - - -			-						ASSEMBLY, cable (J80 to J75) (see FIG. 1 FRONT)

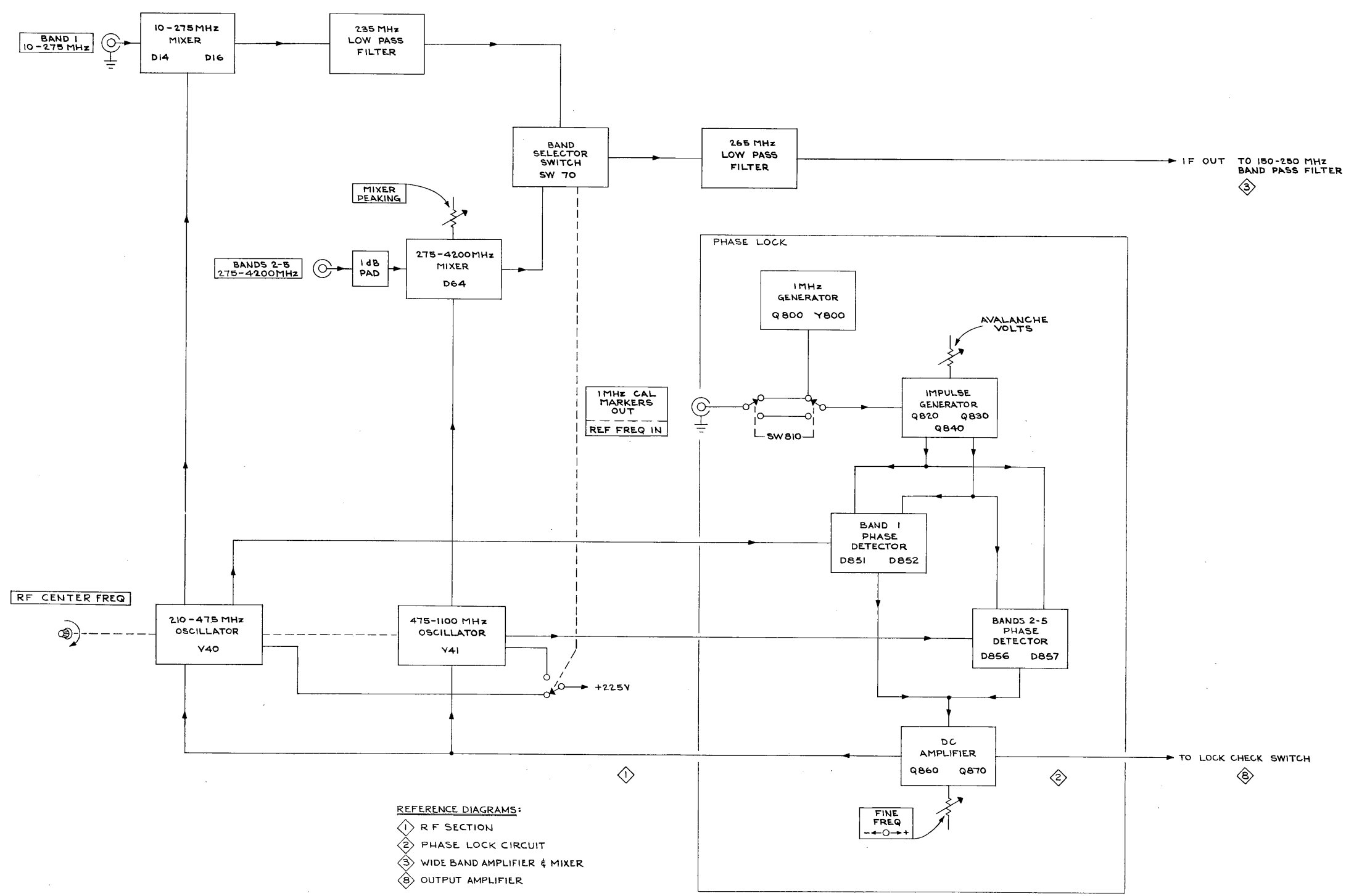

TYPE 1L20 SPECTRUM ANALYZER

A

1165
RF AND PHASE LOCK BLOCK DIAGRAM

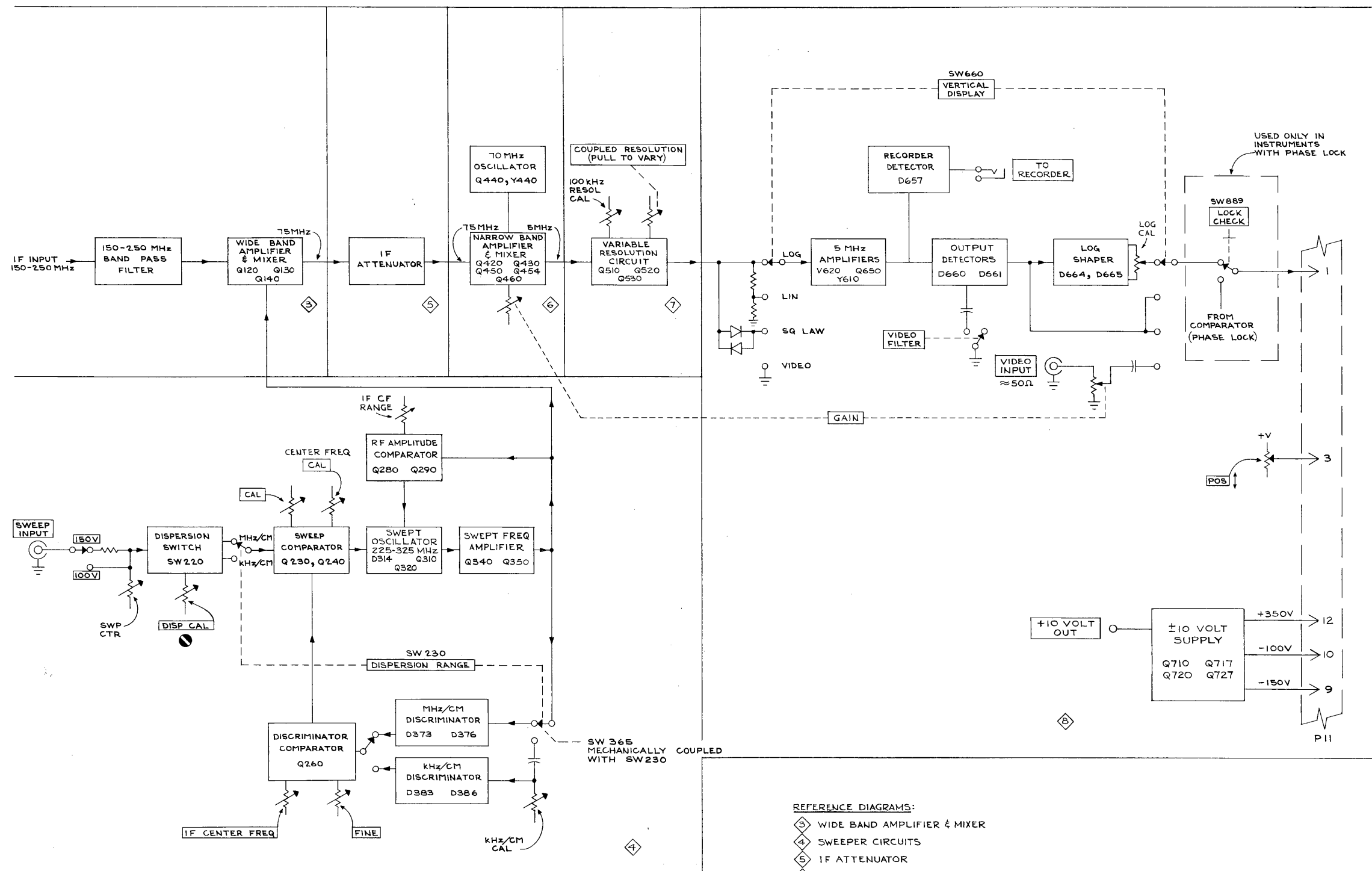

IF SYSTEM BLOCK DIAGRAM

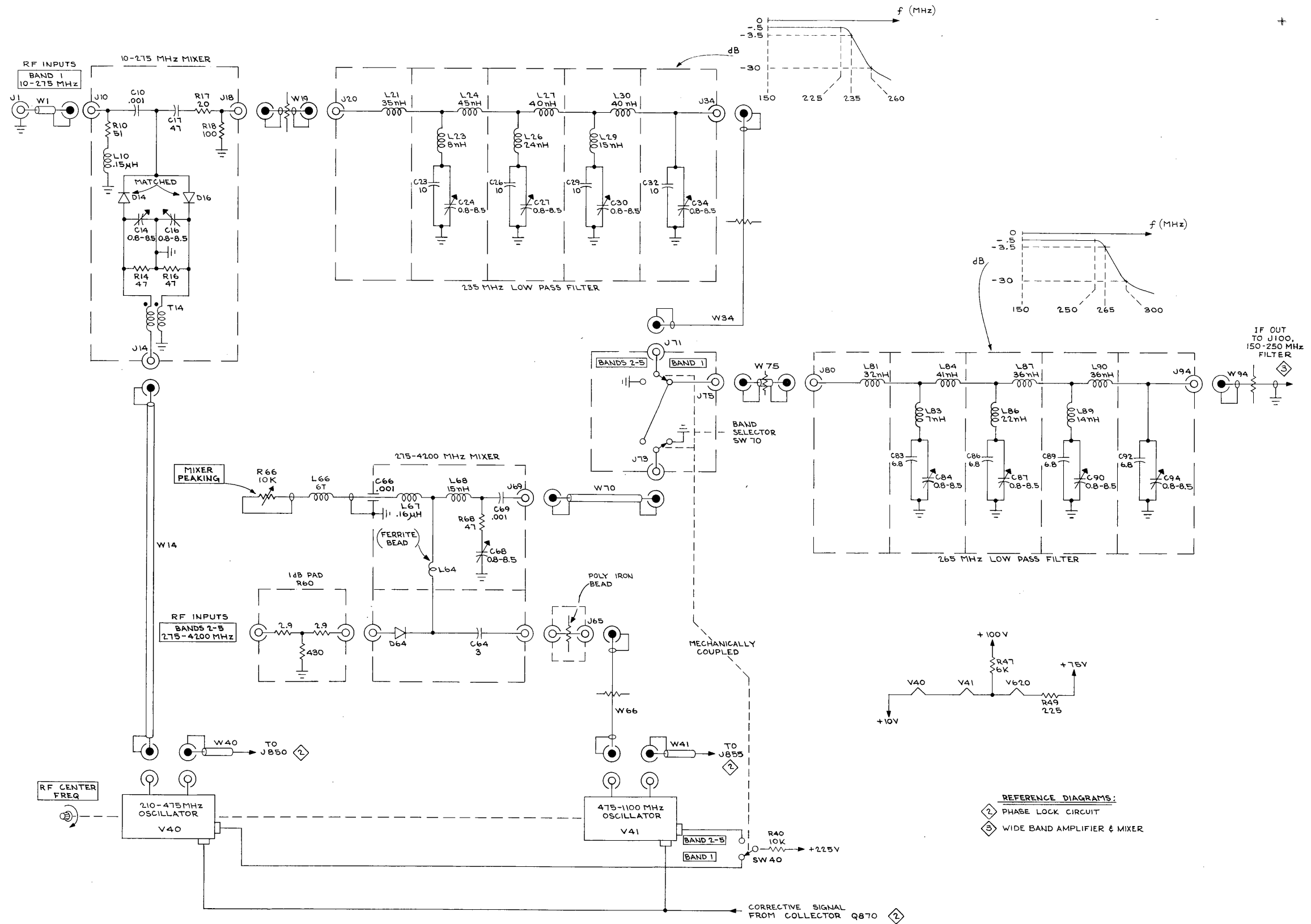

TYPE IL20 SPECTRUM ANALYZER

SEE PARTS LIST FOR SEMICONDUCTOR TYPES

A

RF SECTION ①

RF SECTION ①

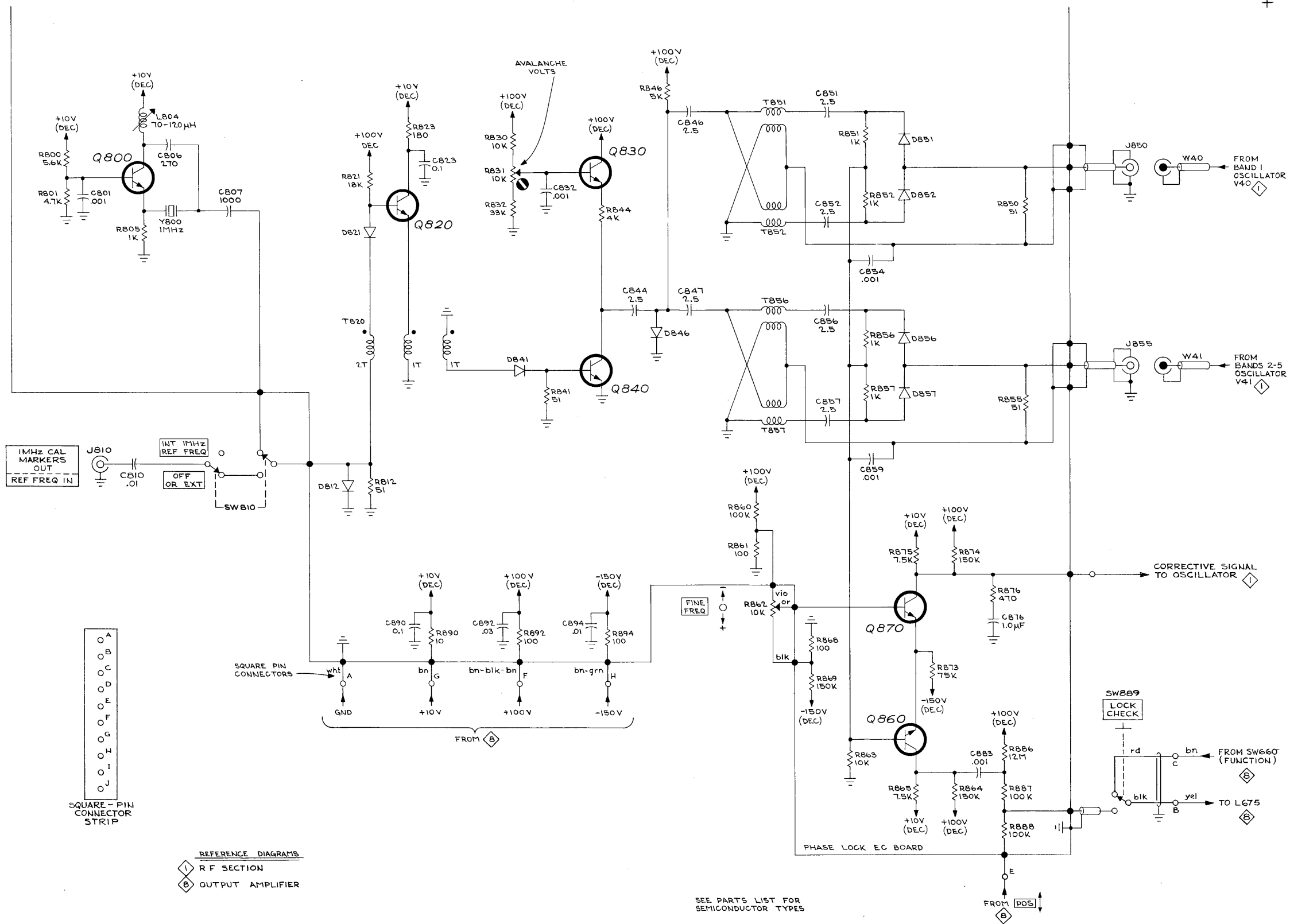

TYPE 1L20 SPECTRUM ANALYZER

A

PHASE LOCK CIRCUIT

SEE PARTS LIST FOR SEMICONDUCTOR TYPES

REFERENCE DIAGRAMS
 1 RF SECTION
 2 OUTPUT AMPLIFIER

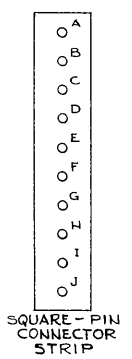

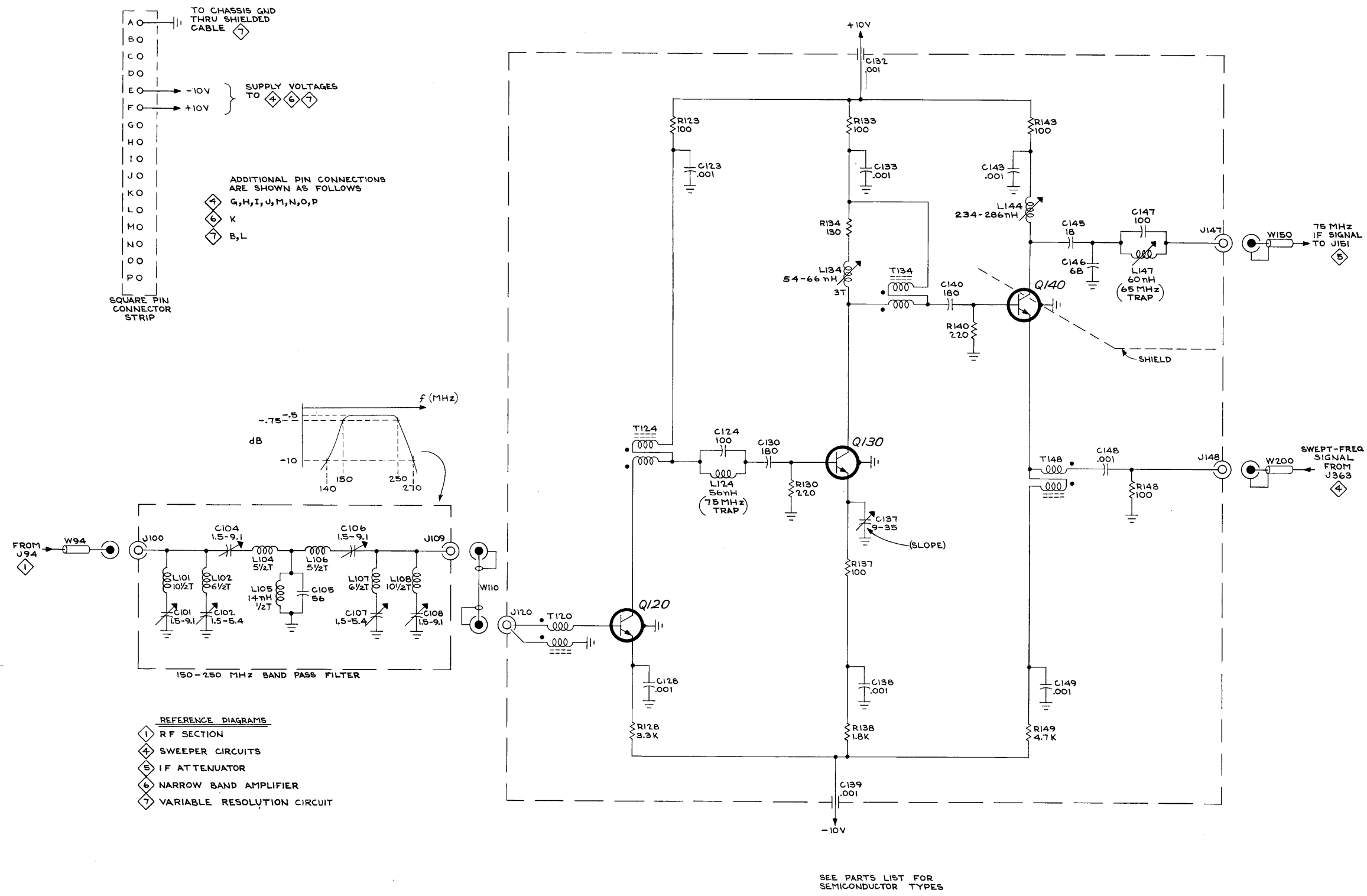

TYPE 1L20/1L30 SPECTRUM ANALYZER

A

1165
WIDE BAND AMPLIFIER AND MIXER 3

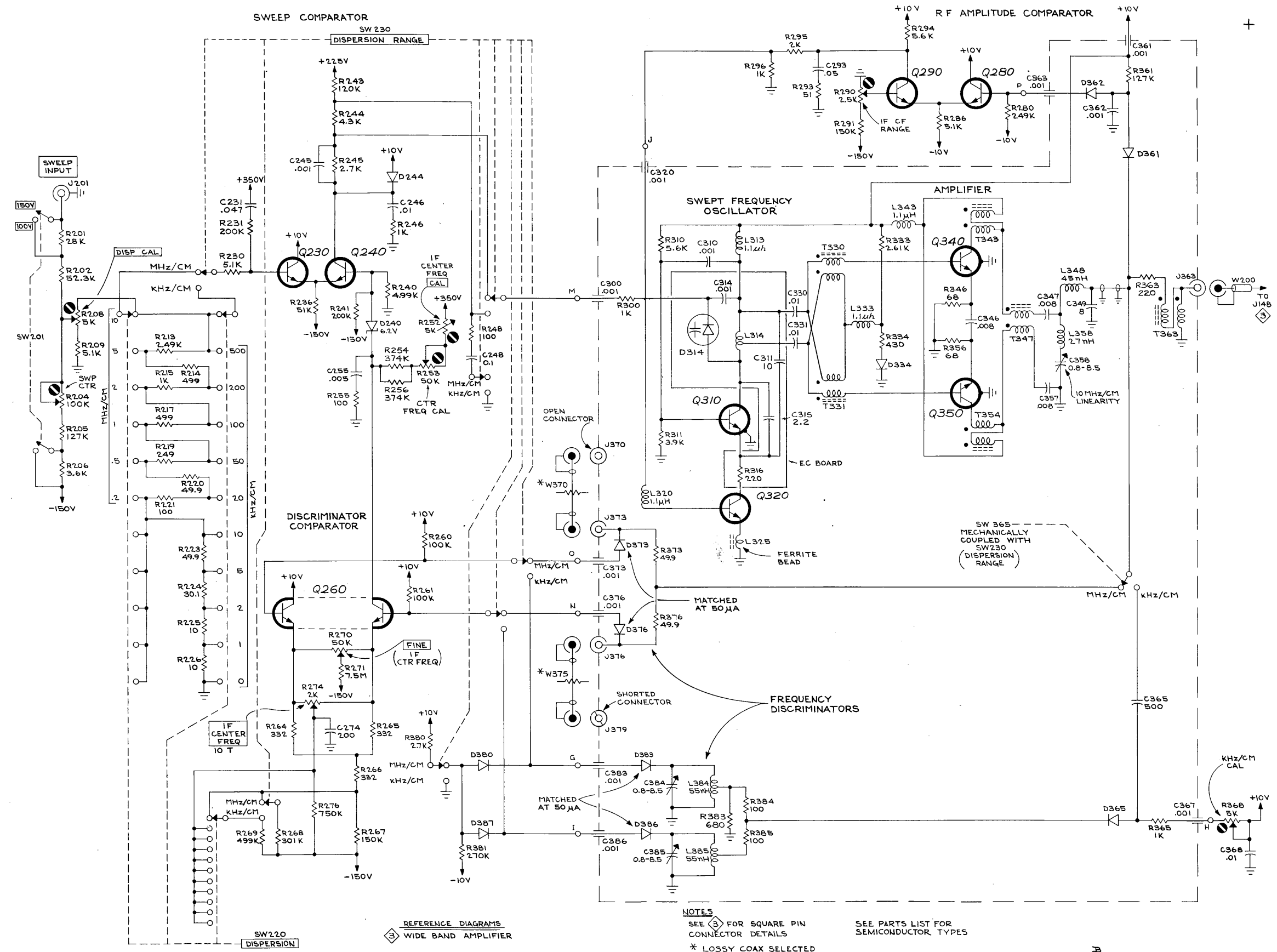

TYPE IL20/IL30 SPECTRUM ANALYZER

REFERENCE DIAGRAMS
 ③ WIDE BAND AMPLIFIER

NOTES
 SEE ③ FOR SQUARE PIN CONNECTOR DETAILS
 SEE PARTS LIST FOR SEMICONDUCTOR TYPES
 * LOSSY COAX SELECTED FOR BEST LINEARITY OF DISCRIMINATOR

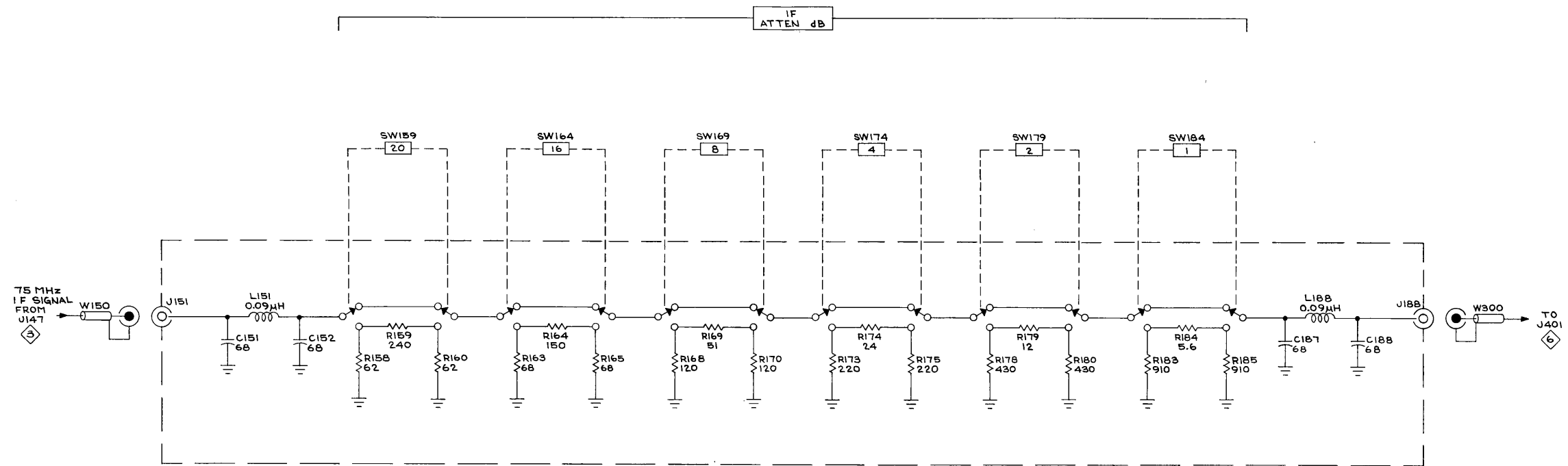

REFERENCE DIAGRAMS

- ③ WIDE BAND AMPLIFIER & MIXER
- ⑥ NARROW BAND IF AMPLIFIER
70MHz OSCILLATOR & MIXER

C151, L151, C152, C187, L188, C188 FORM A LOW PASS FILTER. CHARACTERISTIC:

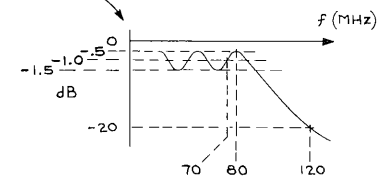

TYPE IL20/IL30 SPECTRUM ANALYZER

A

IF ATTENUATOR

IF ATTENUATOR ⑤

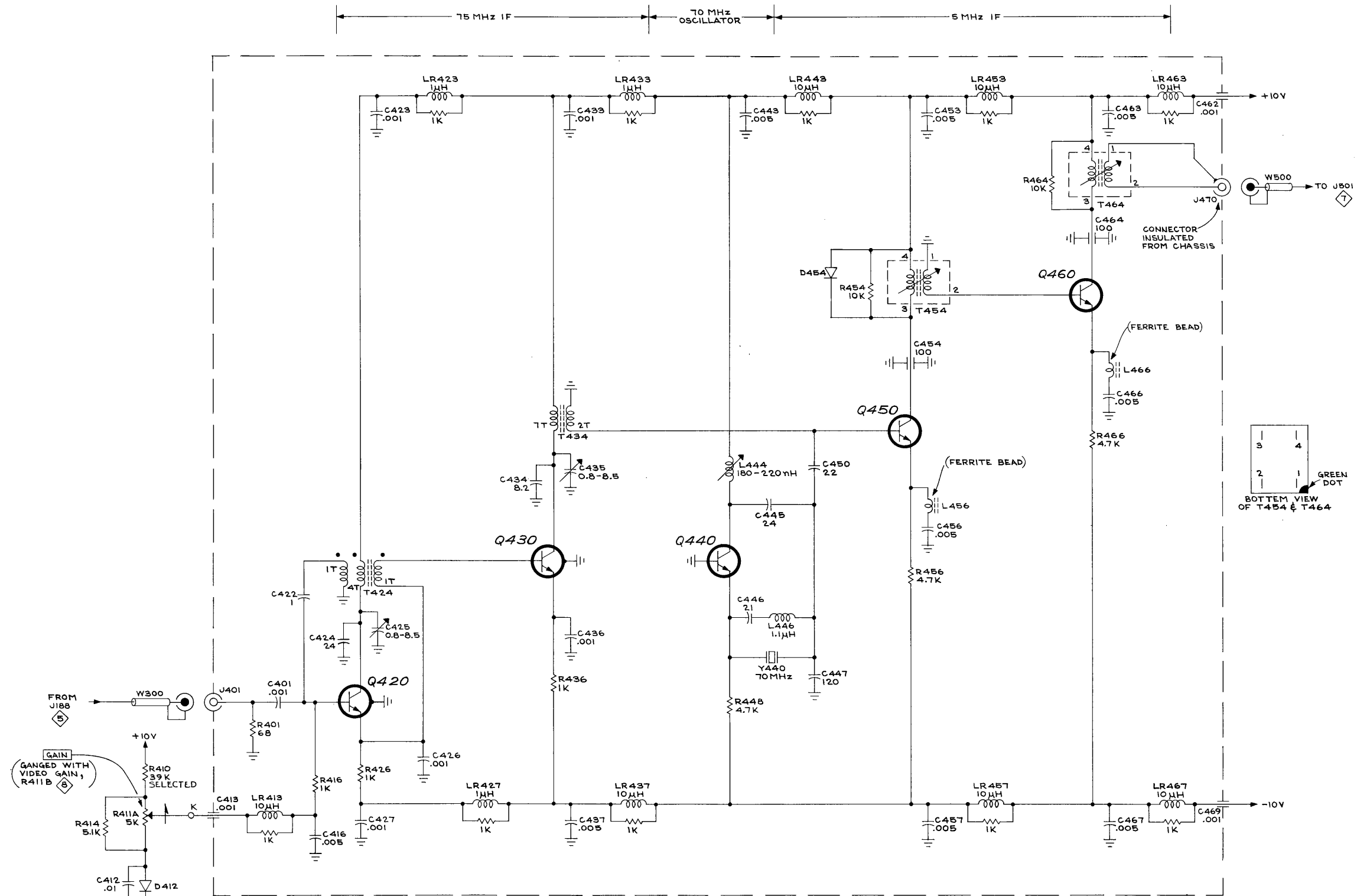

- REFERENCE DIAGRAMS
- ⊠ WIDE BAND AMPLIFIER & MIXER
 - ⊡ IF ATTENUATOR
 - ⊢ VARIABLE RESOLUTION CIRCUITS
 - ⊣ OUTPUT AMPLIFIER

NOTES:

- SEE PARTS LIST FOR SEMICONDUCTOR TYPES
- SEE ⊠ FOR SQUARE PIN CONNECTOR DETAILS

TYPE IL20/IL30 SPECTRUM ANALYZER

A

NARROW BAND IF AMPLIFIER
70MHz OSCILLATOR & MIXER

N B IF AMPL 70 MHz OSC

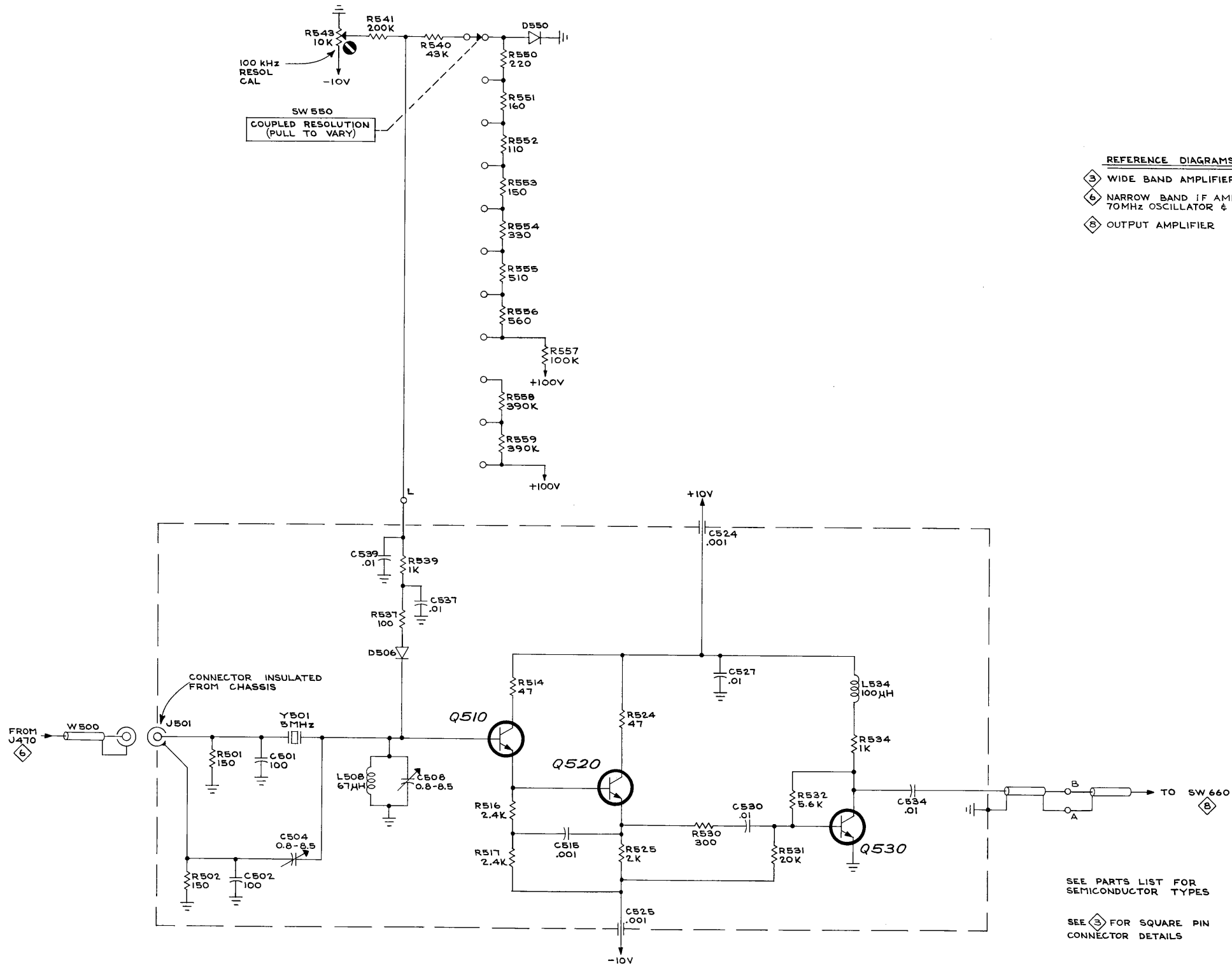
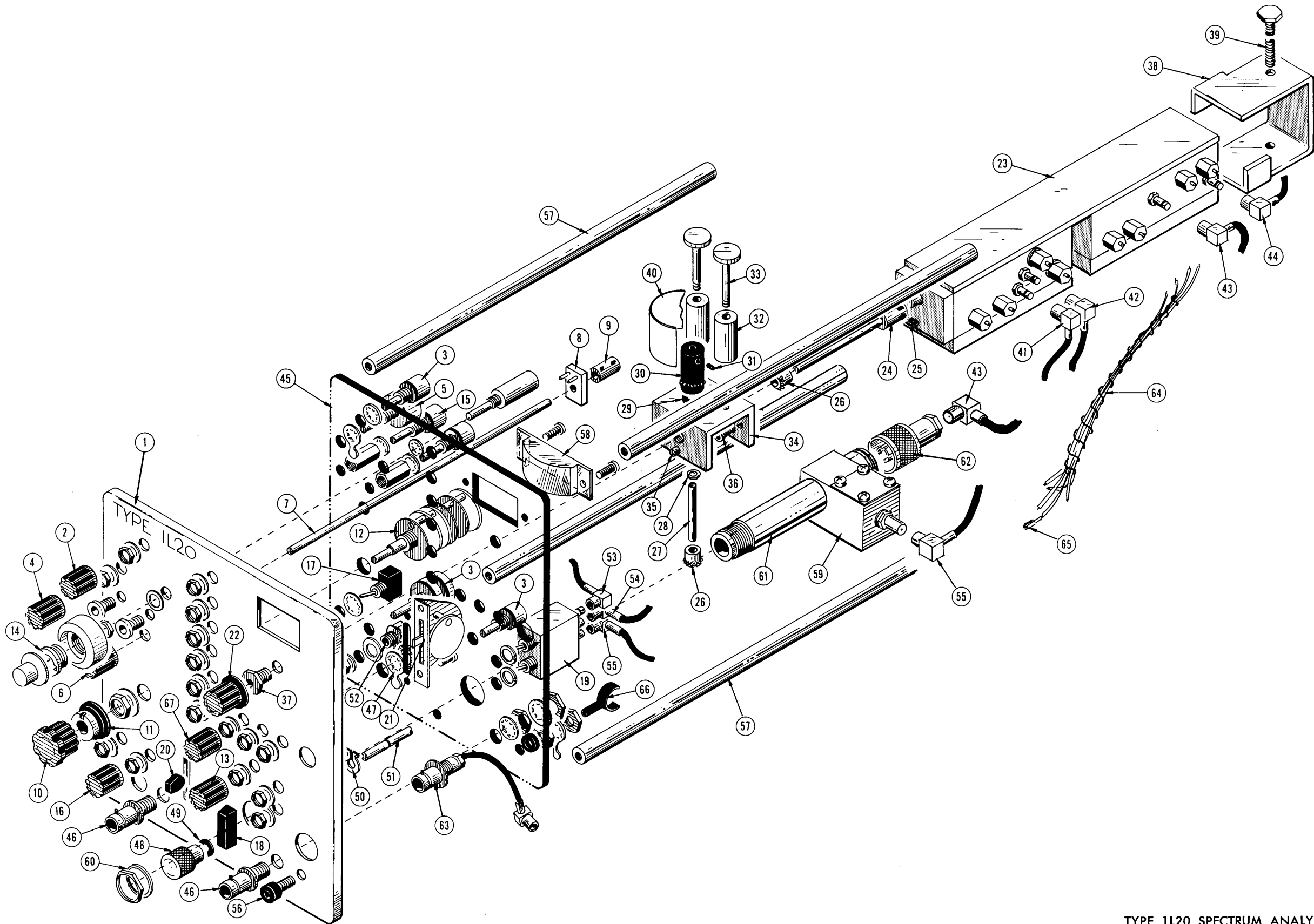

FIG. 1 FRONT



A
L

TYPE 1L20 SPECTRUM ANALYZER

FIG. 1

FIG. 2 REAR & CHASSIS

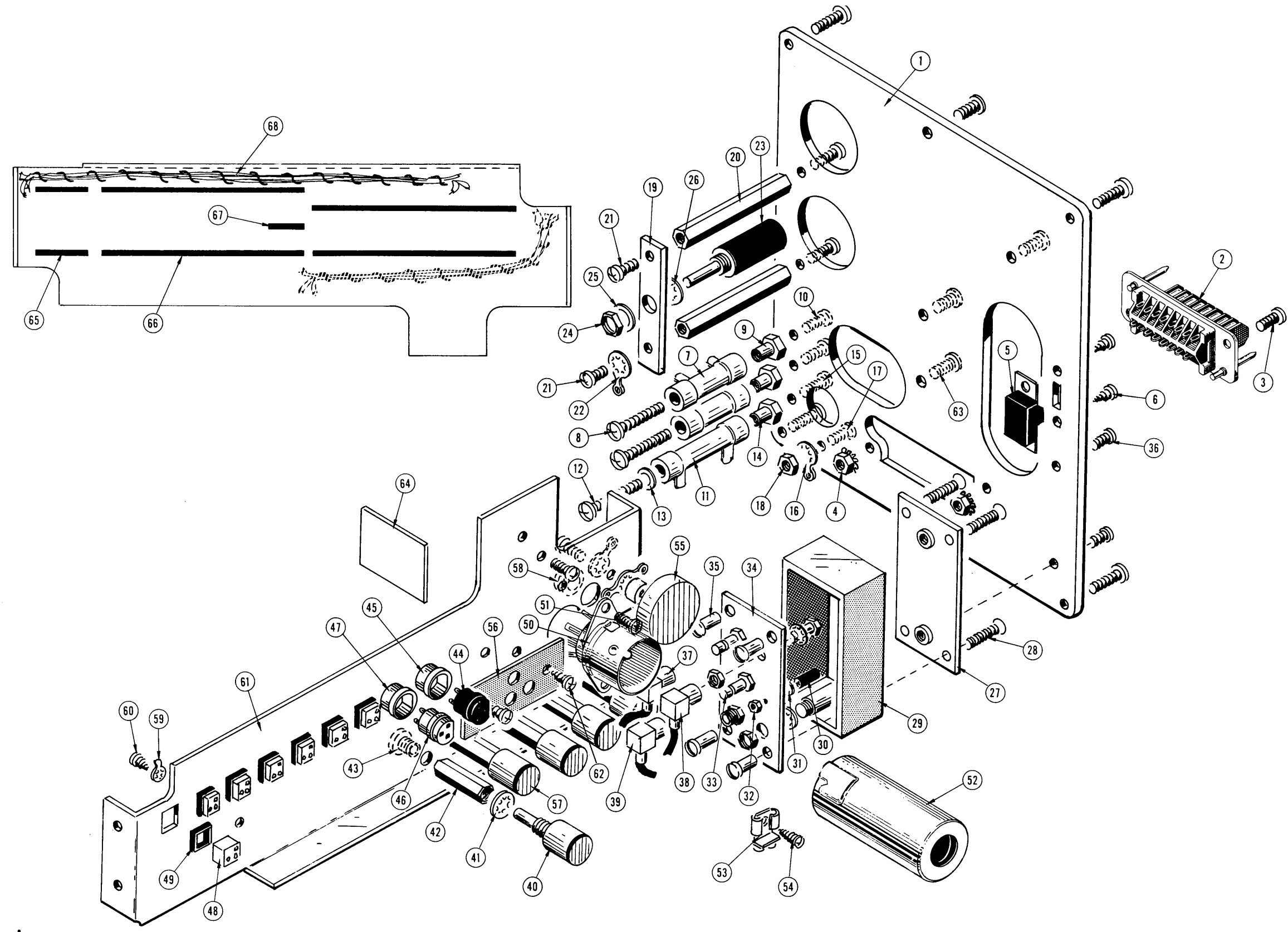

L A

TYPE 1L20 SPECTRUM ANALYZER

FIG. 2

FIG. 3 IF CHASSIS

FIG. 3

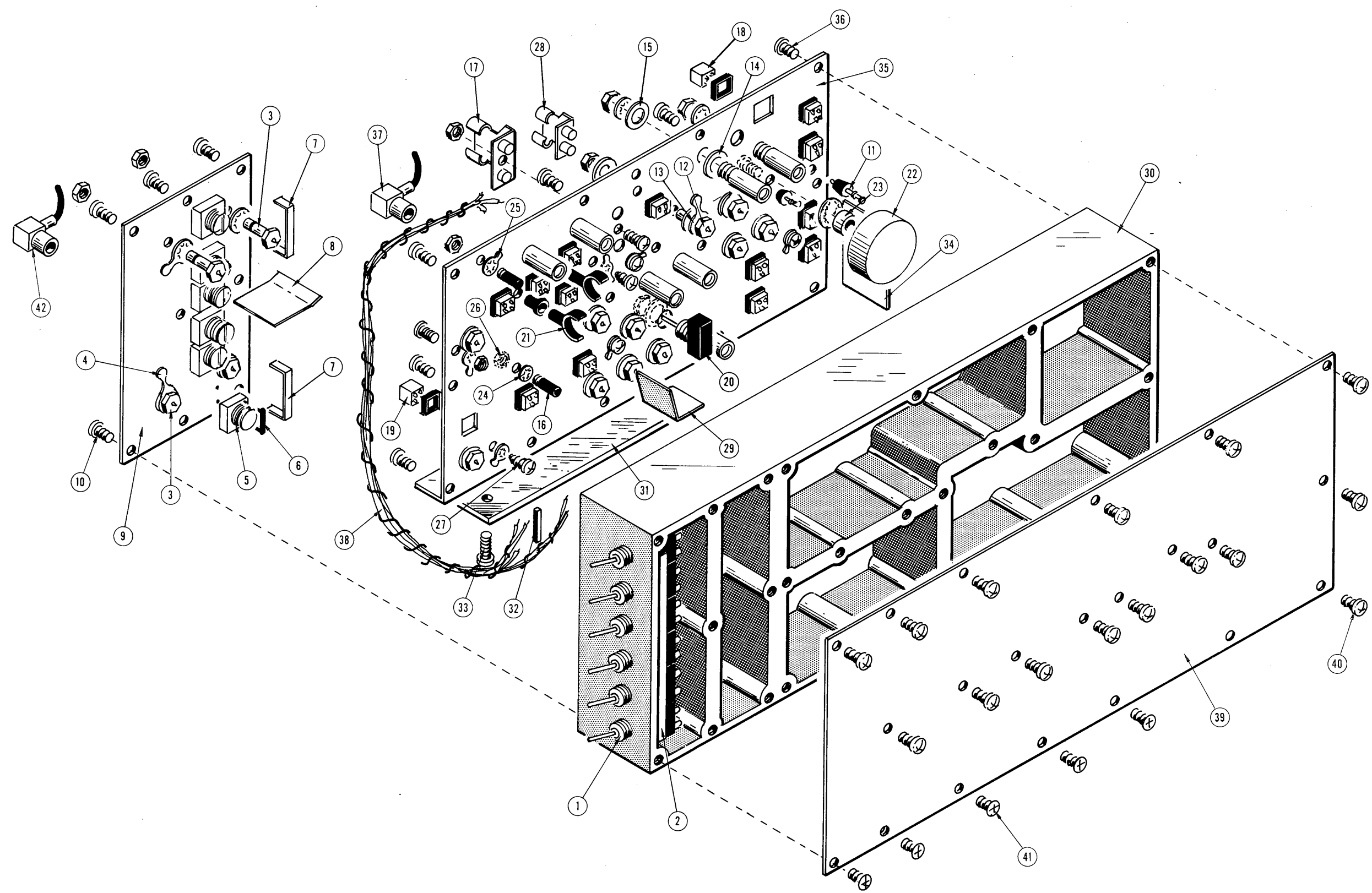

A
L

TYPE 1120 SPECTRUM ANALYZER

FIG. 4 LOW PASS FILTER & PHASE LOCK ASSEMBLY

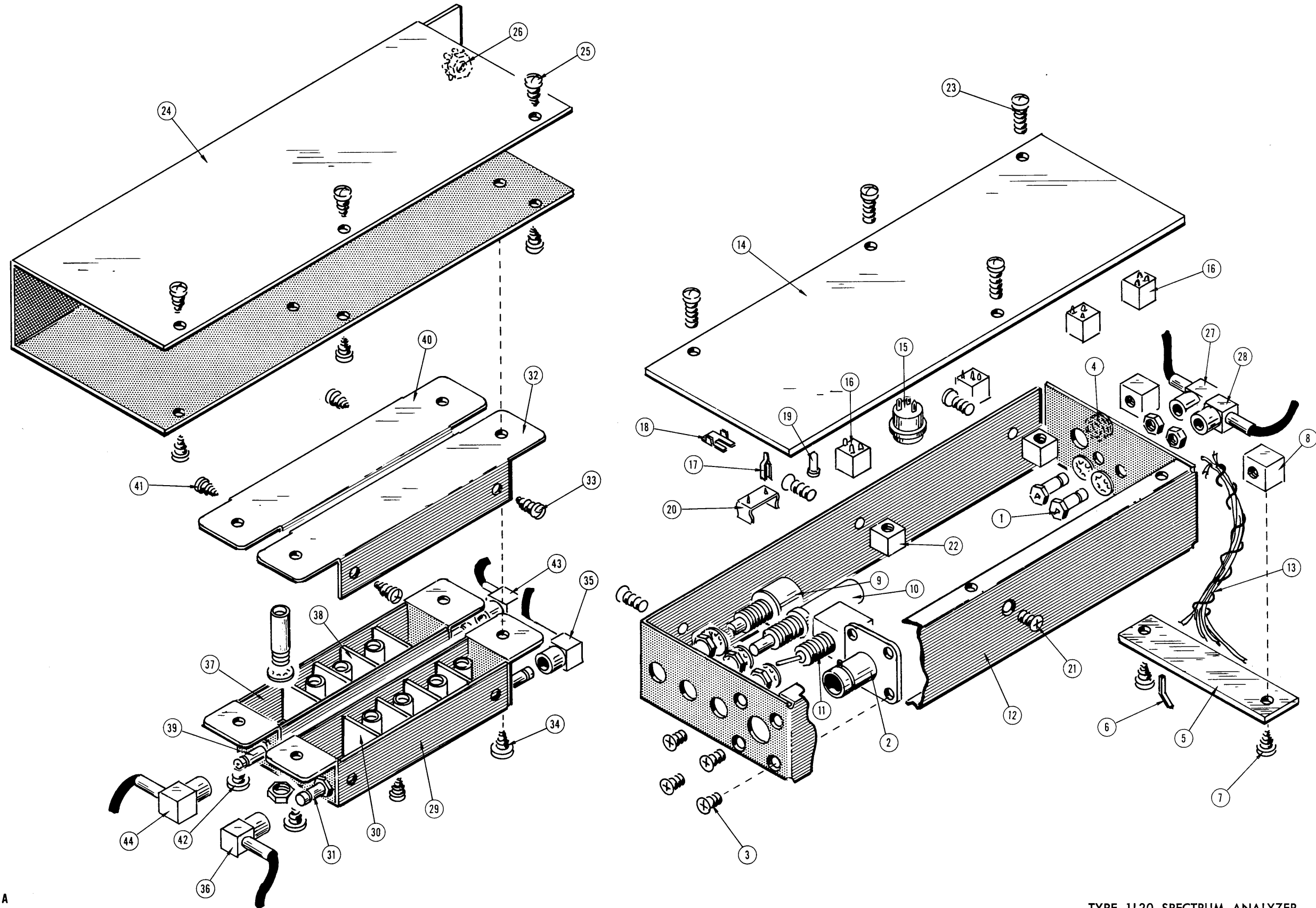
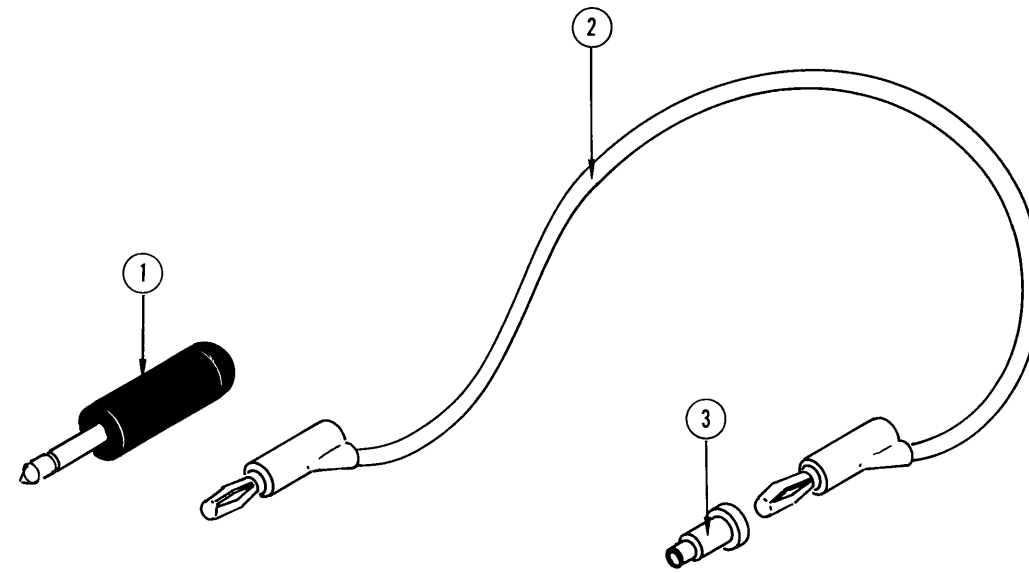

FIG. 4

TYPE 1120 SPECTRUM ANALYZER

FIG. 5 STANDARD ACCESSORIES

OPTIONAL ACCESSORIES



L
A

Fig. & Index No.	Tektronix Part No.	Serial/Model No. Eff	No. Disc	Qty	Q					Description
					1	2	3	4	5	
5-1	134-0052-00			1						1 PLUG, red
-2	012-0091-00			1						1 CORD, patch, BNC to banana, red, 18 inches long
-3	134-0076-00 070-0519-00			1 2						1 PLUG, protector 2 MANUAL, instruction (not shown)

FIG. 5 ACCESSORIES

MANUAL CHANGE INFORMATION

At Tektronix, we continually strive to keep up with latest electronic developments by adding circuit and component improvements to our instruments as soon as they are developed and tested.

Sometimes, due to printing and shipping requirements, we can't get these changes immediately into printed manuals. Hence, your manual may contain new change information on following pages. If it does not, your manual is correct as printed.

TYPE 1L20

TYPE 1L30

PARTS LIST CORRECTION

CHANGE TO:

R823

304-0181-00

180 Ω

1W

10%

TYPE 1L20/1L30

PARTS LIST CORRECTION

CHANGE TO:

L804	114-0208-00	90-150 μ H	Var		
R260	321-0423-00	249 $k\Omega$	1/8 W	1%	
R261	321-0423-00	249 $k\Omega$	1/8 W	1%	
R373	315-0510-00	51 Ω	1/4 W	5%	
R376	315-0510-00	51 Ω	1/4 W	5%	
R876	315-0101-00	100 Ω	1/4 W	5%	

TEXT CORRECTION

Section 1 Characteristics

Page 1-2.

Characteristic	Performance Requirement	Supplemental Information
		FINE Control
.2-5 MHz/CM Dispersion	$\geq (\pm 1 \text{ MHz})$	
10 MHz/CM Dispersion	$\geq (\pm 1 \text{ MHz})$	
TO RECORDER Sensitivity		With <u>6</u> cm LIN Display

Section 3 Circuit Description

Page 3-6. In the 4th and 5th lines from the bottom of the first column, delete: -- to slightly exceed the graticule limits

Section 4 Maintenance

Page 4-3. In the last line of the second column, delete: --, the three control nuts you removed in Step 4, --

Page 4-4. In Table 4-3, change the color code for Pin F as follows:

F	White -- brown-black- <u>brown</u> tracers (+100 V)
---	---

Page 4-7. Some manuals were printed without the voltage and waveform data referred to on this page. If you need this data, contact your Tektronix field engineer.

Section 5 Performance Check

Page 5-2. In Step 3d, change the third line to read: -- DISP CAL adjustment for one marker per centimeter from --

Page 5-8. Add the following step:

18. +10 V DC OUT Voltage Check

1. Connect a 500 Ω load resistor between ground and the +10 V DC OUT connector.

2. Measure the voltage across the load resistor. Check for 10 volts ± 0.5 volts.

Section 6 Calibration

Page 6-4. In Step 7, change the last sentence to read:

Check for +7.0 volts at Pin D with the FINE FREQ control at 0 and the RF CENTER FREQ control set at 250 for Band 1.

In Step 9, delete "L144".

In Step 14, change " ≤ 26 dB" to " ≥ 26 dB".

Page 6-7. In Fig. 6-5(B), change "Ninth Marker" to "Fifth Marker".

In Step 2c, (top of page), change "10 mS" to "10 nS".

Page 6-11. Change Step 7c to read:

c. Turn the tuning slug of L804 counterclockwise until the oscillations stop. Then turn the slug clockwise about 1/2 turn past the point at which the oscillations start again.

In Step 7e, change "5 MHz" to "2 MHz".

Change Step 7g to read:

g. Set the RF CENTER FREQ dial to 250 and the RF INPUT switch to BAND 1. Adjust the FINE FREQ control for +7.0 volts at Pin D. The knob should index at 0. Reset the knob on its shaft if necessary.

Page 6-13. Change Step 9a to read:

a. Connect the equipment as shown in Fig. 6-14.

In Step 9d, delete: -- times the noise level.

Page 6-13
(continued)

In Step 9e, delete the references to L444 and add the following step:

f. Turn the tuning slug of L444 counterclockwise until the oscillations stop. Then turn the slug clockwise about 1/4 turn past the point at which the oscillations start up again.

Page 6-14.

In Fig. 6-17, change "Trigger Signal" to "Horizontal Signal".

In Step 10a, change "Band 1" to "Bands 2-5".

In Step 10c, add the following controls to the preset list:

IF ATTEN	20 dB to On
GAIN	Fully clockwise

In Step 10e, delete: -- and the GAIN control --

In Step 10h, change "74 MHz" to "200 MHz".

Change Step 11a to read:

a. Set up the equipment as directed in Steps 10b through 10f.

Page 6-15.

In Fig. 6-19, delete "(step 6-c)" and "(step 6g)". Change "C66" to "C68".

In Step 12e, change "see Fig. 6-20" to "see Fig. 6-19".

In Step 12f, change "RF PEAKING" to MIXER PEAKING".

In Step 12g, change "C66" to "C68". The two lines at the top of the second column should be moved down to become the 2nd and 3rd lines of Step 12g.

Page 6-16.

In Fig. 6-20, delete "BANDS 2-5 RF INPUT".

Page 6-22.

Change the last line of the NOTE in the first column to read the "applicable oscillators".

Change Step 2 to read:

2. Connect the power to the oscillator (see Fig. 6-28).
Apply +7.0 volts from an external source to the varactor bias terminal.

Page 6-23.

In Step 3, change "see Fig. 27". to "see Fig. 28".

Page 6-23. Change Step 4 to read:
(continued)

4. Apply +7.0 volts from an external source to the varactor bias terminals.

In Step 8, change "see Fig. 6-27" to "see Fig. 6-28".

In Steps 10 & 11, change "see Fig. 6-30" to "see Fig. 6-29".

Page 6-24. In Steps 3 & 8, change "see Fig. 6-27" to "see Fig. 6-28".

Change Step 4 to read:

4. Apply +7.0 volts from an external source to the varactor bias terminals.

In Steps 12, 13 & 14, change "see Fig. 6-28" to "see Fig. 6-29".

Section 7 Electrical Parts List

Change to:

C10	283-0067-00	0.001 μ F	Cer	200 V	10%
-----	-------------	---------------	-----	-------	-----

Section 9 Diagrams and Illustrations

In Fig. 5 ACCESSORIES (last pull-out page in the manual), the drawing shows a patch cord with banana plugs on both ends; it should have a banana plug on one end and a BNC plug on the other.

SCHEMATIC CORRECTION

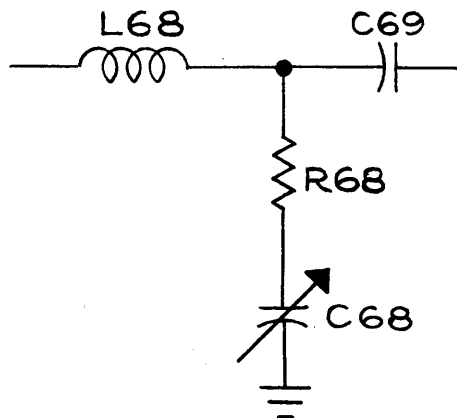

PART RF SECTION

